

www.en.wanas.pl



WANAS[®]

PRODUCT CATALOG







The WANAS company is a Polish manufacturer of modern ventilation units called recuperators. The production plant is located in Rzeszów in the Podkarpackie voivodeship. Many years of work in the ventilation and heating industry, experience and passion for creation resulted in the creation of energy-saving and reliable recuperators. To create our products, we used the knowledge about the needs of the end user, which in turn allowed us to design products that ensure a high level of comfort of use in both residential and service construction.

The recipients of our products are customers from all over Poland, and since 2015 we have been constantly expanding the export of our products to European Union countries and eastern markets. We offer recuperators with a capacity **of 200 to 1300 m³/h**. Our products are characterized by quiet operation, high thermal efficiency, low energy consumption and low operating costs related to the replacement of filters. As standard, recuperators have an intuitive, touch-sensitive controller and with the purchase of an Internet module, also the possibility of controlling the control panel via the Internet using mobile devices.

Interest in the subject of mechanical ventilation and customer awareness is growing year by year, which mobilizes us to create new, innovative solutions that meet the expectations of the most demanding users.

Our engineers and employees make every effort to ensure that the final product is of the highest quality - from design to production. We are constantly striving to ensure that WANAS recuperators serve their users in the best possible way in everyday life, being characterized by functionality and high comfort of use.

KNOW OUR SOLUTIONS



The standard recuperator is equipped with a V1 DISPLAY.



The standard recuperator is equipped with a V2 DISPLAY.



The standard recuperator is equipped with a V3 DISPLAY.



Modbus RTU is one of the most popular communication protocols in automation systems – it allows you to connect the recuperator to the so-called smart home.



The XF system enables automatic balancing of the installation by continuously measuring the current supply and exhaust air flow.



Air handling unit has a modern, smart pre-heater that adjusts its power to the temperature of the air, its amount and flow.



The standard recuperator has a built-in internet module, thanks to which it can be remotely controlled.



Bypass is used to cool the rooms. It is activated mainly in the summer, when the temperature in the room is higher than the comfort temperature and the outside temperature at night is lower than it.



The evaporative air humidifier used inside the unit will help maintain the appropriate level of humidity in the rooms, especially in winter.



The plastic, high-efficiency counterflow heat exchanger used in the recuperator is made of high-quality polystyrene.

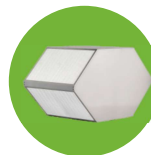

The recuperator has an aluminum counterflow heat exchanger. The heat exchanger maintains the best ratio of efficiency to air flow resistance.



To ensure high hygiene and durability, the inside of the recuperator was powder coated with polyester paint.



Selected partitions inside the air handling unit are made of a special insulating board.

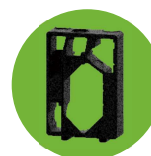

The body of the recuperator is made entirely of durable foamed polypropylene.



The recuperator has a wireless humidity sensor included in the price.



The built-in heater-cooler module, when connected to a heat and/or cooling source, will additionally cool or heat up the air supplied to the rooms.

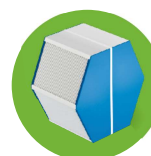

Possibility of using an enthalpy exchanger with moisture recovery.

CHOOSE THE BEST RECUPERATOR FOR YOU

COMBO



It is the only recuperator on the market with a unique combination of as many as four functions - ventilation, air humidification, heating and cooling. The innovative design of the recuperator, the use of highly efficient heat exchangers and the modulated heater ensure its high thermal efficiency and low energy consumption.



BLACK



Black series air handling units are unique because of its casing made of durable foamed polypropylene. Design and new technology solutions offers an air handling unit with exceptional properties. Black series have universal casing suitable for right and left mounting option.



HI-TECH



HI-TECH series air handling units are offering newest technology solutions enclosed in a compact casing. Illuminated logo and a wall mounted glass controller will delight the lovers of modern design. Steel casing with hybrid system and innovative technology guarantees the elimination of thermal bridges as well as stability of entire unit.



CLASSIC XF



Wanas Classic series have been upgraded with the most desired auto-balancing flow XF system and extensive motherboard, these two allows to track status of current air flow in m^3/h .



CLASSIC



WANAS bestselling air handling units are offering high standard of components and best proven solutions included in the attractive price. As a standard Wanas offers smart touch controller, wall bracket and odorless siphon.



HIGH STANDARD OF EQUIPMENT

All WANAS air handling units have the necessary assembly kit that includes smart touch controller, wire cable between air handling unit & controller, wall bracket and odorless siphon, set of two stage filters (primary & secondary) and smart pre-heater. All these are delivered to customer without extra charge. Air handling units 815H, 815V, 900H & 1300H because of its dimensions have adjustable leveling feet instead of wall bracket.

RADIO SENSOR

miniControl

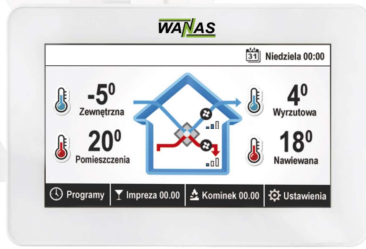

44,3 mm x 44,3 mm x 17,0 mm



POSSIBILITY
TO USE

3 WIRELESS
SENSORS FOR
THE INSTALLATION

2 PARAMETERS
READ
SIMULTANEOUSLY
°C RH

COMPATIBLE
WITH THE
WALL CONTROLLER

V2

Parameter

Unit

Parameter	Unit	
Temp. measurement range	°C	from -30 to 50
Humidity measurement range	% RH	from 10 to 95
Operating frequency	Mhz	868
Height	mm	44,3
Width	mm	44,3
Depth	mm	17
Battery power supply	-	Cr2032
Operating range in open area	m	10

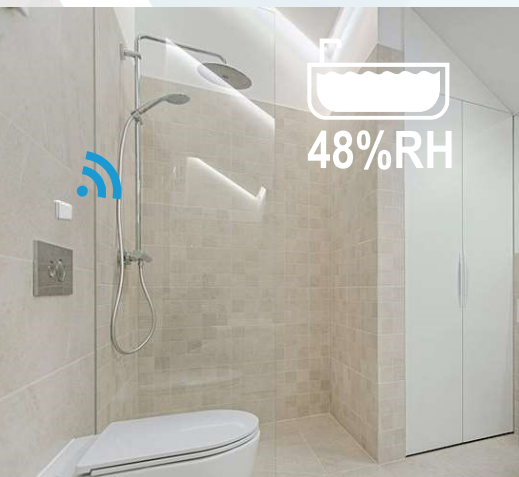

CHOOSE A **UNIQUE** SOLUTION

The wireless miniControl sensor is a device used to measure humidity and temperature in a room. It increases the efficiency of the air handling unit if the humidity in the room is too high, or turns on the humidifier, or reduces the efficiency when it's too dry in the house. The sensor is compatible with the newest V2 driver. It is possible to register 3 sensors for each installation, e.g. two in the bathroom and one in the bedroom. The miniControl sensor can be connected to the system at any time, and due to the radio communication, it does not require a prior connection to the electricity network. Due to its small size, the sensor can be installed virtually anywhere.

WALL-MOUNTED REGULATOR

multiSENSE

IT MEASURES UP TO

3
PARAMETERS
SIMULTANEOUSLY
CO₂ °C RH

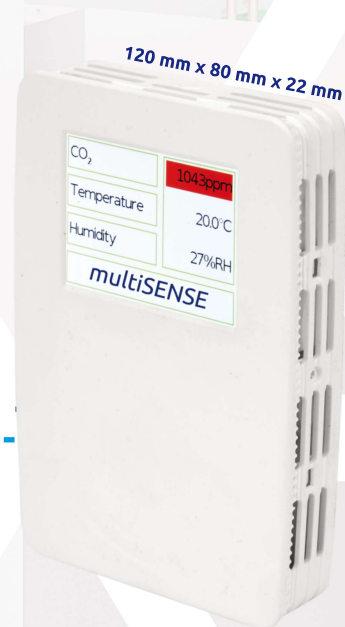
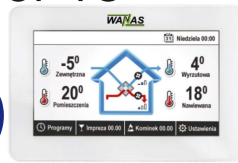

Parameter	Unit	
CO ₂ measurement range	ppm	from 0 to 3000
Temperature measurement range	°C	from 0 to 50
Zakres pomiaru wilgotności	%RH	from 0 to 100
High	mm	120
Width	mm	80
Depth	mm	22
Power supply	-	24 V DC
Output	-	0-10 V, ON/OFF

multiSENSE is a wall-mounted, wired controller that controls the operation of the air handling unit based on the readings of up to three parameters. The sensor accurately measures the CO₂ concentration, temperature and relative humidity in the room. The device is equipped with a clear touch screen and allows checking the 24-hour or weekly history of measurements, as it saves the readings. The multiSENSE sensor is wall-mounted and can be connected to the ventilation system with a 6 x 0.5 cable. The regulator is compatible with all WANAS recuperators and WANAS UMECTO humidifiers.

ROOM SENSOR

roomControl

80 mm x 80 mm x 21,6 mm



2
PARAMETERS
READ
SIMULTANEOUSLY
°C RH



V1

COMPATIBLE WITH THE WALL CONTROLLER

Parameter	Unit	
Humidity settings range	%RH	from 30 to 80
Operating temperature	°C	from 5 to 50
Humidity measurement error	%RH	+/- 3,5
Max. contact load capacity	A	1
Power supply	-	2xAAA, 1,5V
Width	mm	80
High	mm	80
Depth	mm	21,6

roomControl is a two-mode, wired sensor that controls the operation of a recuperator. The sensor is designed to read the temperature and relative humidity in the room, and subsequently, to maintain the pre-set humidity based on the readings. The device is equipped with a display for ongoing measurement reading. The HIS function allows setting the air humidity hysteresis from 5% to 25% by entering the tolerance above which the device switches the humidifier on to achieve the required humidity level. The sensor is compatible with WANAS CLASSIC series recuperators and WANAS UMECTO humidifiers. The roomControl sensor can be connected to the ventilation system using the 2 x 0.75 cable.

AIR HANDLING UNITS **COMBO** 4in1



AIR HANDLING UNIT **WANAS 430 COMBO PRESTIGE**

The unique solution used in COMBO recuperators is protected by a patent application of the Republic of Poland.

SEE INSIDE

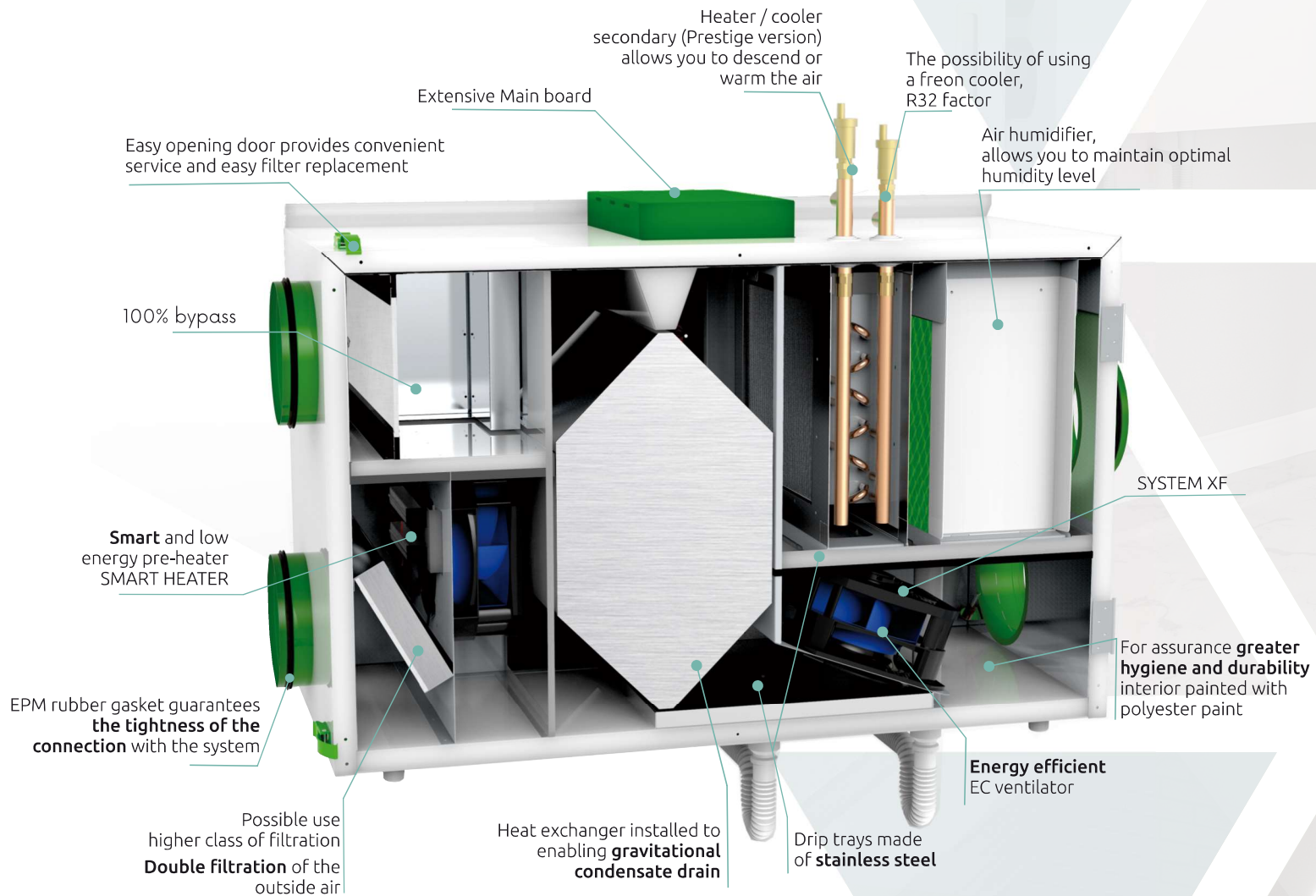

WANAS COMBO PRESTIGE XF

WANAS COMBO PRESTIGE is only one air handling unit on the market that offers combination of four devices in one case. This unique device will ventilate your homeplace, warm the air in the winter time, cooldown in summer and keep the house moist all year round according to your preferences. COMBO PRESTIGE is the best option for houses equipped with heat pumps or other source of heat and/or cold.

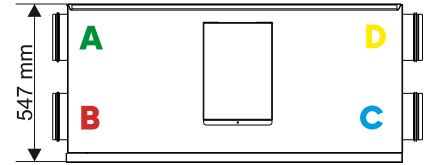
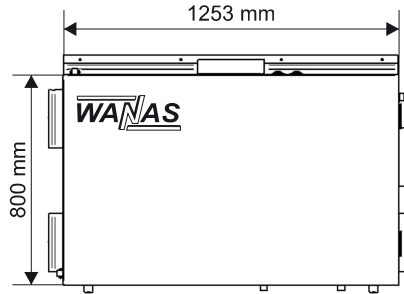

- A - external fresh air
- B - air extraction from rooms
- C - air supply to rooms
- D - spent air discharge to the outside

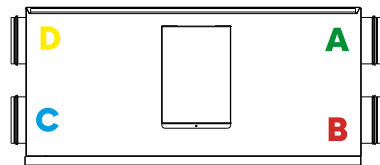

LEFT VERSION

TECHNICAL DATA

		430	630
UEC (unit energy consumption) class	-	A	A
UEC for moderate climate	kWh/(m ² /year)	-38,09	-38,45
UEC for cool climate	kWh/(m ² /year)	-74,61	-75,39
UEC for warm climate	kWh/(m ² /year)	-14,55	-14,67
Max. flow rate (at 100 Pa)	m ³ /h	430	630
Acoustic power (gear I/ acc. to UE 1254/2014)	dB(A)	44/49	46/52
Energy consumption	W	17-161	29-275
Nominal water consumption*	l/h	2,8	2,8
Pre-heater power	W	1 000	1 000
Humidifier energy consumption	W	2-18	2-18
Power supply	V/Hz	230/50	230/50
Stub pipe diameter	mm	200	200
Water connector diameter	cal	3/4	3/4
Max. efficiency acc. to UE 1254/2014, ΔT=13°C, at 200 m ³ /h, SWM	%	82,6	87,3
Efficiency acc. to UE 1254/2014, dT=13°C, SWM	%	80,8	82,4
Max. heating power	kW	3,1	3,6
Max. cooling power	kW	3,2	3,7
Height	mm	800	800
Width	mm	1253	1253
Depth	mm	547	547
Weight	kg	96	95
Filter class		ISO COARSE 75% + ePM 10 50%	

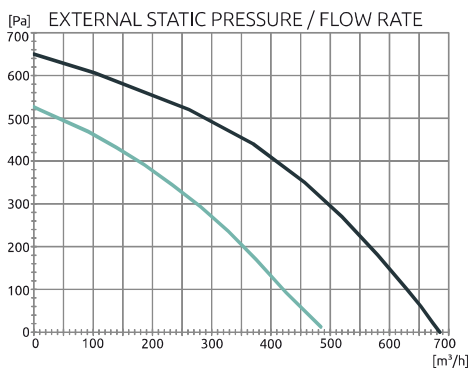
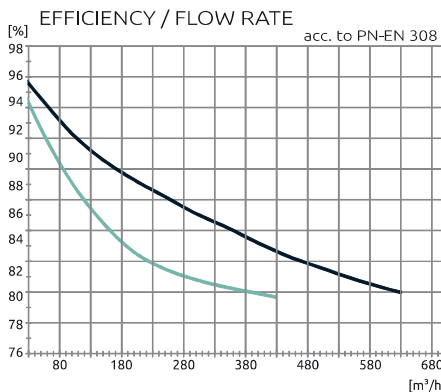

— COMBO 430
— COMBO 630

IN STANDARD



OPTIONS ADDITIONAL

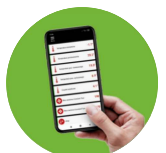

WANAS COMBO LIGHT XF

WANAS COMBO LIGHT is an unique combination of humidifier and air handling unit in one case. Evaporative humidifier maintain an appropriate level of humidity in homeplace especially during winter time and provide expected climate comfort. Additional advantages of COMBO air handling unit are extremely quiet and energy savings EC fans, maintaining high efficiency and heat recovery. The device can be upgraded with water or freon cooler lateron.

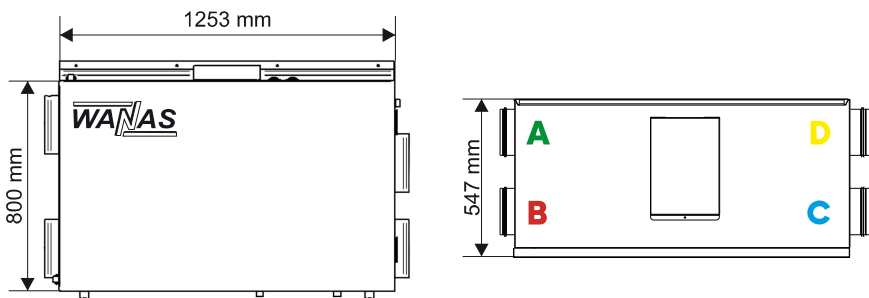

- A - external fresh air
- B - air extraction from rooms
- C - air supply to rooms
- D - spent air discharge to the outside

TECHNICAL DATA

		430	630
UEC (unit energy consumption) class	-	A	A
UEC for moderate climate	kWh/(m ² /year)	-38,09	-38,45
UEC for cool climate	kWh/(m ² /year)	-74,61	-75,39
UEC for warm climate	kWh/(m ² /year)	-14,55	-14,67
Max. flow rate (at 100 Pa)	m ³ /h	430	630
Acoustic power (gear I/ acc. to UE 1254/2014)	dB(A)	44/49	46/52
Energy consumption	W	17-161	29-275
Nominal water consumption	l/h	2,8	2,8
Pre-heater power	W	1 000	1 000
Secondary heater power	W	1 000	1 000
Humidifier energy consumption	W	2-18	2-18
Power supply	V/Hz	230/50	230/50
Stub pipe diameter	mm	200	200
Water connector diameter	cal	3/4	3/4
Max. efficiency acc. to UE 1254/2014, ΔT=13°C, at 200 m ³ /h, SWM	%	82,6	87,3
Efficiency acc. to UE 1254/2014, dT=13°C, SWM	%	80,8	82,4
Height	mm	800	800
Width	mm	1253	1253
Depth	mm	547	547
Weight	kg	89	88

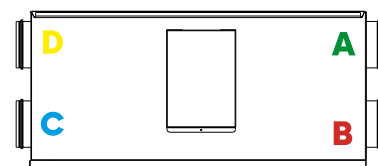

LEFT VERSION

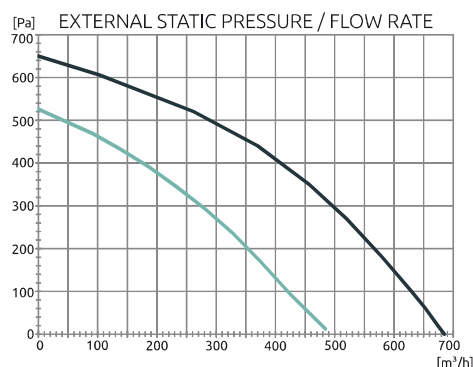
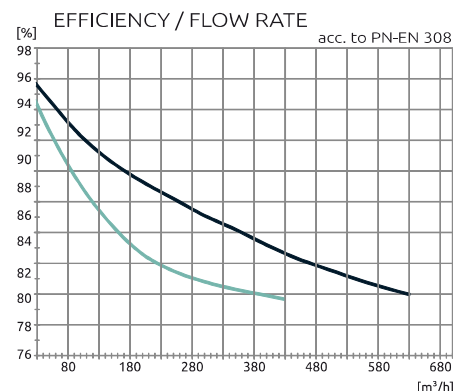

— COMBO 430
— COMBO 630

Filter class

ISO COARSE 75%
+ ePM 10 50%



IN STANDARD

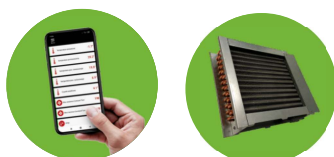

ADDITIONAL
OPTIONS

AIR HANDLING UNITS **BLACK**



AIR HANDLING UNIT WANAS BLACK 300V

SEE INSIDE

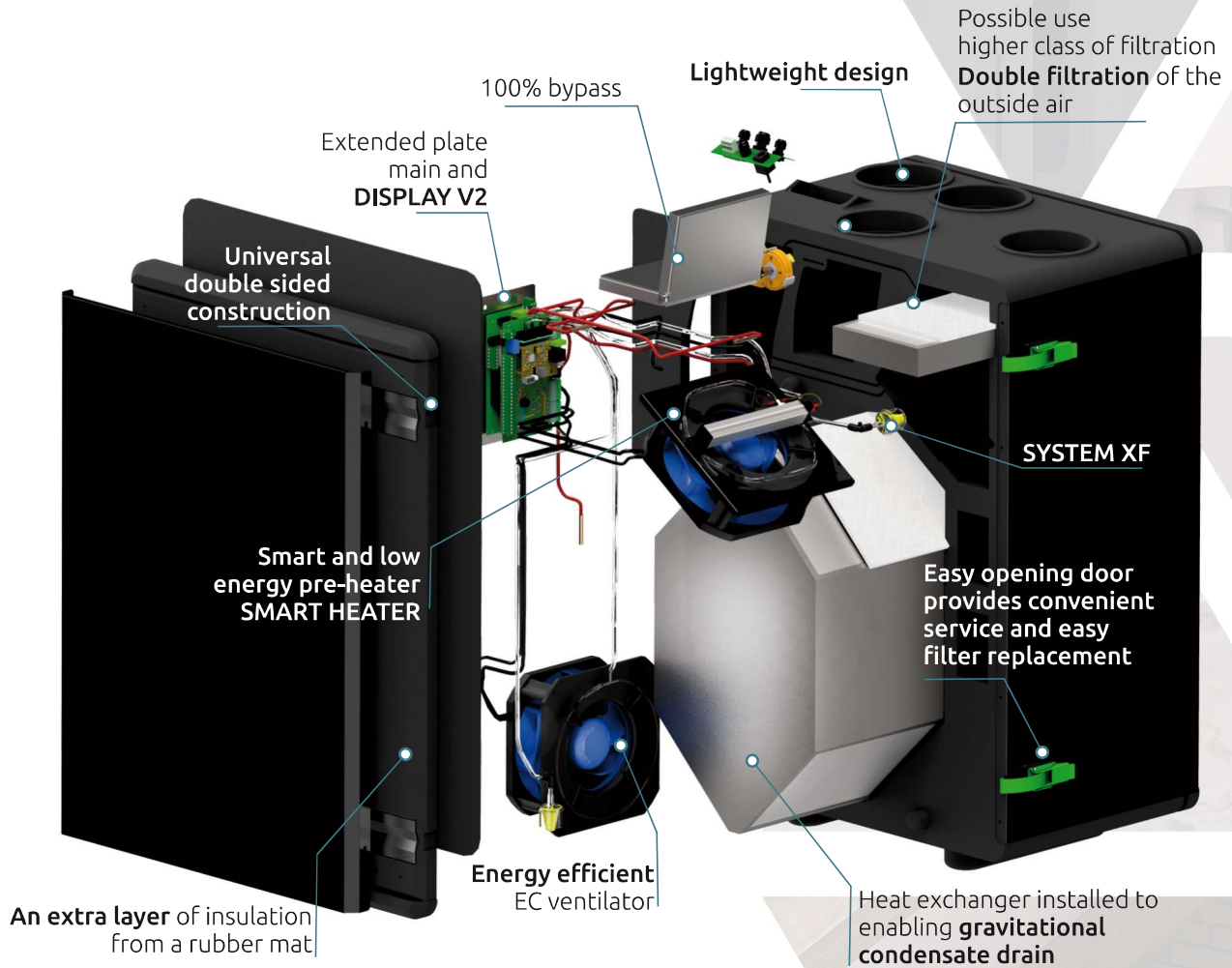

NEW! Display V3

Minimalistic controls let you use it easily way with all the most important functions offered by the unit.

READS ALERTS AND NOTIFICATIONS

MODE DURATION PARTY

NETWORK CONNECTION WIFI

PARTY MODE

FIREPLACE MODE

PAIR YOUR DEVICE USING BLUETOOTH

STOP 60' TEMPORARY SHUTDOWN FANS

Expandable
o expansion module

WANAS BLACK XF

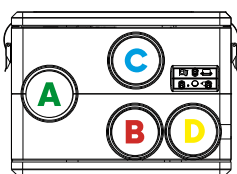

LEFT VERSION

Black XF series air handling units are unique because of its casing made of durable foamed polypropylene. Design and new technology solutions offer an air handling unit with exceptional properties. WANAS BLACK XF offers an auto-balancing flow system, which constantly measures supply air flow rate & extract as well. Black series have a universal casing suitable for right and left mounting options.

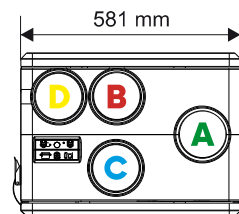
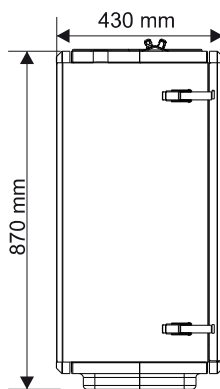

- A - external fresh air
- B - air extraction from rooms
- C - air supply to rooms
- D - spent air discharge to the outside

TECHNICAL DATA

200V XF 300V XF

UEC (unit energy consumption) class	-	A	A
UEC for moderate climate	kWh/(m ² /year)	-37,41	-34,17
UEC for cool climate	kWh/(m ² /year)	-74,89	-70,87
UEC for warm climate	kWh/(m ² /year)	-13,31	-10,52
Max. flow rate (at 100 Pa)	m ³ /h	200	332
Acoustic power (gear I/ acc. to UE 1254/2014)	dB(A)	39/46	42/55
External static pressure (at nominal value)	Pa	100	150
Energy consumption	W	16-84	25-208
Pre-heater power	W	500	500
Power supply	V/Hz	230/50	230/50
Stub pipe diameter	mm	125	125
Max. efficiency acc. to UE 1254/2014, ΔT=13°C, at 120 m ³ /h, SWM	%	93,5	93,5
Efficiency acc. to UE 1254/2014, dT=13°C, SWM	%	84,5	81,5
Height	mm	870	870
Width	mm	581	581
Depth	mm	430	430
Weight	kg	29,5	29,5
Filter class		ISO COARSE 75% + ePM 10 50%	

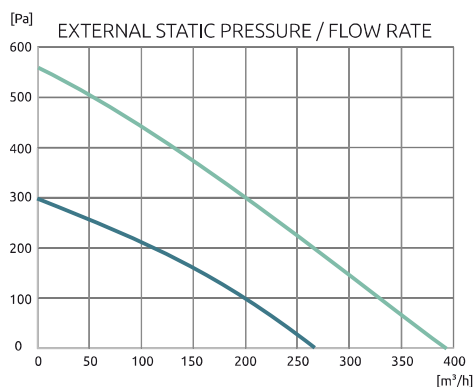
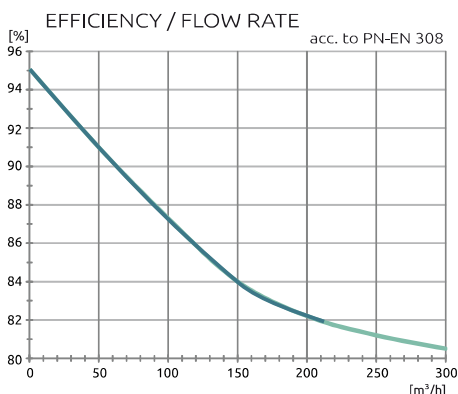

- BLACK 200
- BLACK 300

IN STANDARD



OPTIONS ADDITIONAL

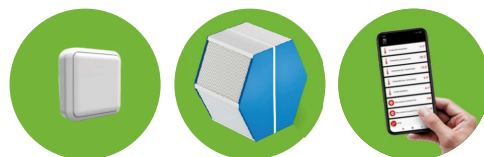

WANAS BLACK

Black series have new designed touch controller DISPLAY V3, wall mounted with access to the basic features. All air handling units have built-in Wi-Fi internet module, thanks to which its control is carried out remotely, using a dedicated application. The application allows you to manage and set installation parameters.

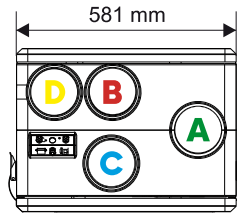
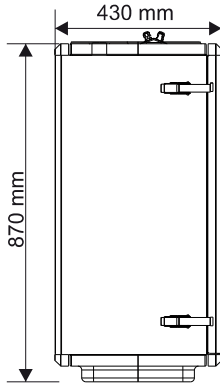

- A - external fresh air
- B - air extraction from rooms
- C - air supply to rooms
- D - spent air discharge to the outside

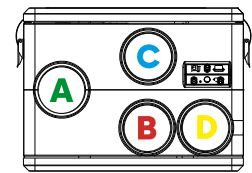

LEFT VERSION

TECHNICAL DATA

		200V	300V
UEC (unit energy consumption) class	-	A	A
UEC for moderate climate	kWh/(m ² /year)	-37,41	-34,17
UEC for cool climate	kWh/(m ² /year)	-74,89	-70,87
UEC for warm climate	kWh/(m ² /year)	-13,31	-10,52
Max. flow rate (at 100 Pa)	m ³ /h	200	332
Acoustic power (gear I/ acc. to UE 1254/2014)	dB(A)	39/46	42/55
External static pressure (at nominal value)	Pa	100	150
Energy consumption	W	16-84	25-208
Pre-heater power	W	500	500
Power supply	V/Hz	230/50	230/50
Stub pipe diameter	mm	125	125
Max. efficiency acc. to UE 1254/2014, ΔT=13°C, at 120 m ³ /h, SWM	%	93,5	93,5
Efficiency acc. to UE 1254/2014, dT=13°C, SWM	%	84,5	81,5
Height	mm	870	870
Width	mm	581	581
Depth	mm	430	430
Weight	kg	29,5	29,5
Filter class		ISO COARSE 75% + ePM 10 50%	

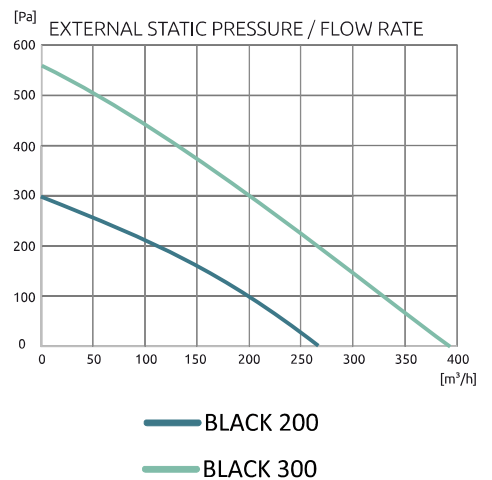
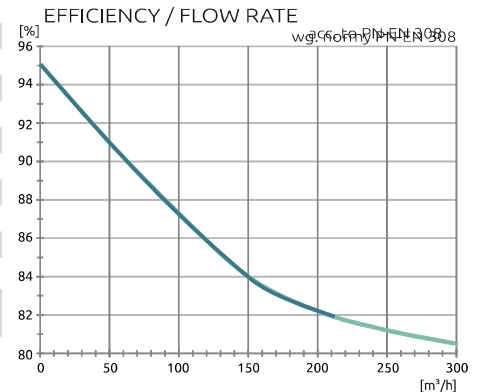

IN STANDARD

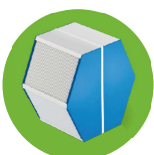

**OPTIONS
ADDITIONAL**

WANAS AIR HANDLING UNITS

HI-TECH

Full of technology!



AIR HANDLING UNIT **WANAS 415V HI-TECH**

SEE INSIDE

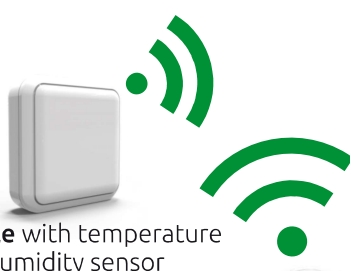
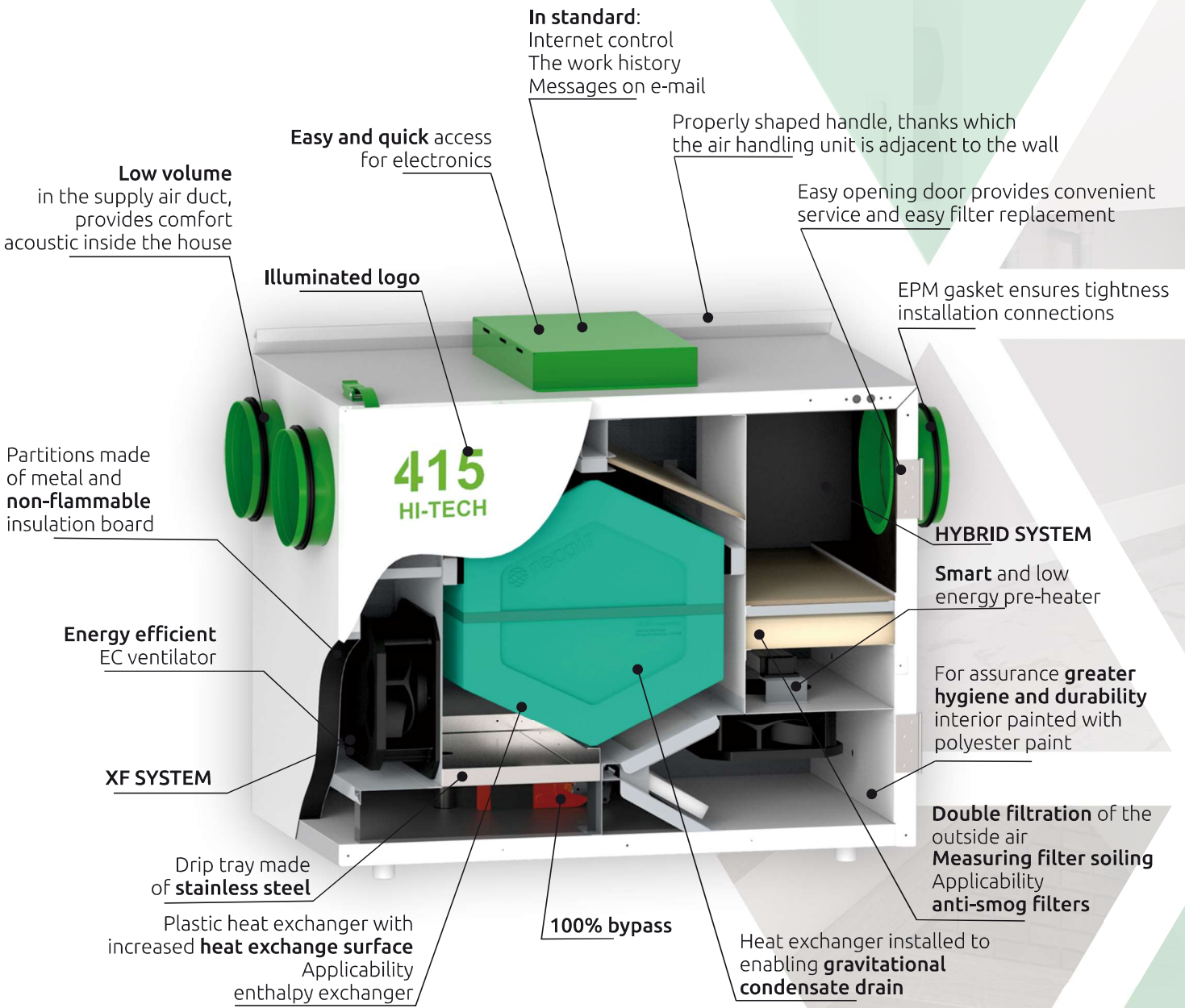

Compatible with temperature and humidity sensor



WANAS 415V HI-TECH — WANAS 415H HI-TECH

WANAS HI-TECH series are modern air handling units with built-in wired internet module, auto-balancing flow system XF, which constantly measures supply air flow rate & extract as well in m³/h, modbus protocol by which you can connect air handling unit to a smart home system.

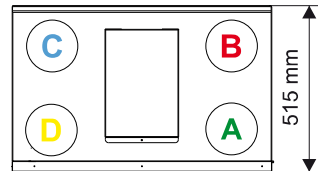
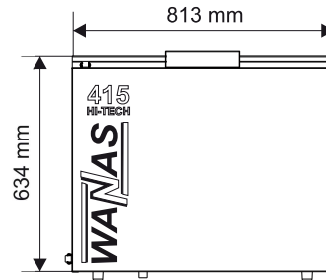

FRONT VERSION V

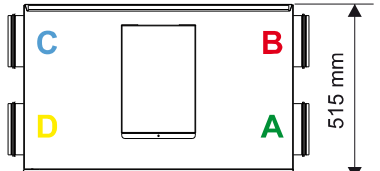
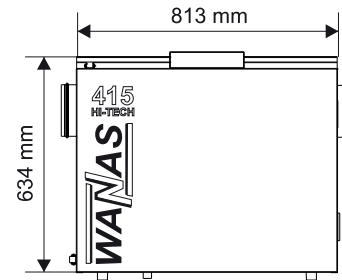

FRONT VERSION H

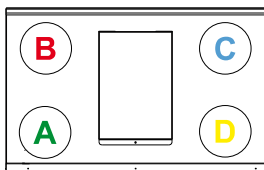

FRONT VERSION V

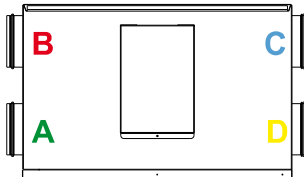

FRONT VERSION H LEFT VERSION

- A - external fresh air
- B - air extraction from rooms
- C - air supply to rooms
- D - spent air discharge to the outside

TECHNICAL DATA

415V HI-TECH 415H HI-TECH

UEC (unit energy consumption) class	-	A
UEC for moderate climate	kWh/(m ² /year)	-34,89
UEC for cool climate	kWh/(m ² /year)	-71,95
UEC for warm climate	kWh/(m ² /year)	-11,03
Max. flow rate (at 100 Pa)	m ³ /h	520
Acoustic power (gear I/ acc. to UE 1254/2014)	dB(A)	44/59
External static pressure (at nominal value)	Pa	235
Energy consumption	W	19-240
Pre-heater power	W	500
Power supply	V/Hz	230/50
Stub pipe diameter	mm	160
Max. efficiency acc. to UE 1254/2014, ΔT=13°C, at 100 m ³ /h, SWM	%	92,8
Efficiency acc. to UE 1254/2014, dT=13°C, SWM	%	82,9
Height	mm	634
Width	mm	813
Depth	mm	515
Weight	kg	61
Filter class	ISO COARSE 75% + ePM 10 50%	

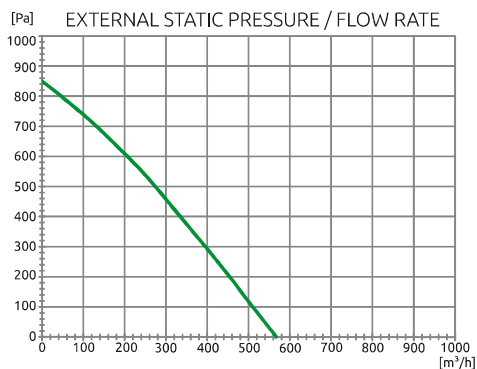
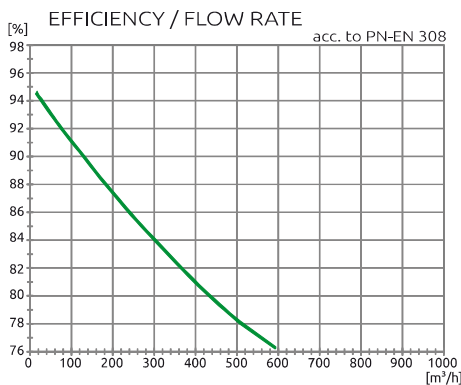

IN STANDARD



OPTIONS
ADDITIONAL

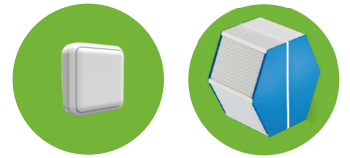

WANAS 615V HI-TECH — WANAS 615H HI-TECH

WANAS air handling units have a smart pre-heater, which automatically adjust its output accordingly to the outside temperature and air flow. The temperature is constantly measured by the sensors to protect the heat exchanger against freezing by warming up supplied air with smart pre-heater.

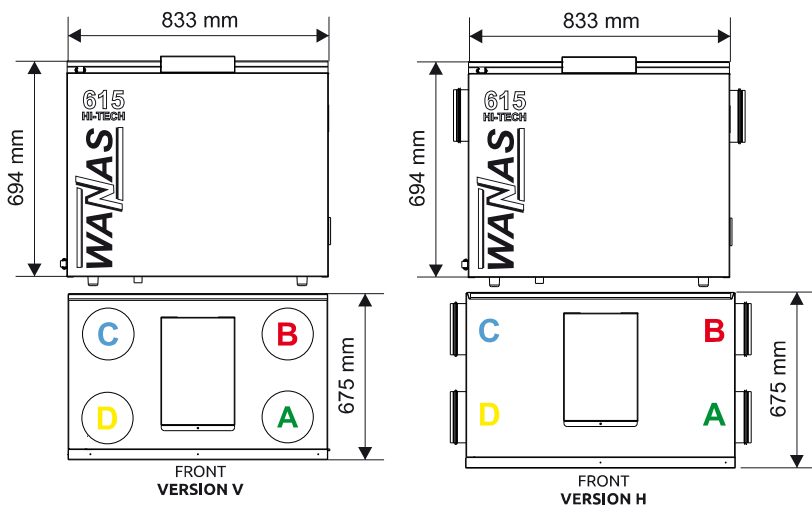

- A - external fresh air
- B - air extraction from rooms
- C - air supply to rooms
- D - spent air discharge to the outside

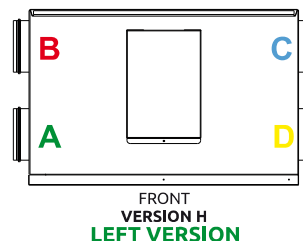
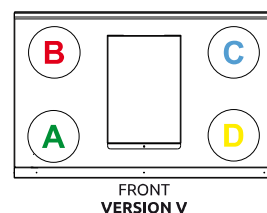

TECHNICAL DATA

615V HI-TECH 615H HI-TECH

UEC (unit energy consumption) class	-	A
UEC for moderate climate	kWh/(m ² /year)	-34,15
UEC for cool climate	kWh/(m ² /year)	-71,16
UEC for warm climate	kWh/(m ² /year)	-10,32
Max. flow rate (at 100 Pa)	m ³ /h	688
Acoustic power (gear I/ acc. to UE 1254/2014)	dB(A)	45/61
External static pressure (at nominal value)	Pa	193
Energy consumption	W	30-377
Pre-heater power	W	500
Power supply	V/Hz	230/50
Stub pipe diameter	mm	200
Max. efficiency acc. to UE 1254/2014, ΔT=13°C, at 100 m ³ /h, SWM	%	93,6
Efficiency acc. to UE 1254/2014, dT=13°C, SWM	%	82,7
Height	mm	694
Width	mm	833
Depth	mm	675
Weight	kg	75,5
Filter class	ISO COARSE 75% + ePM 10 50%	

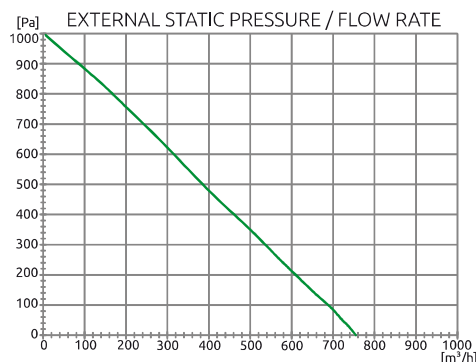
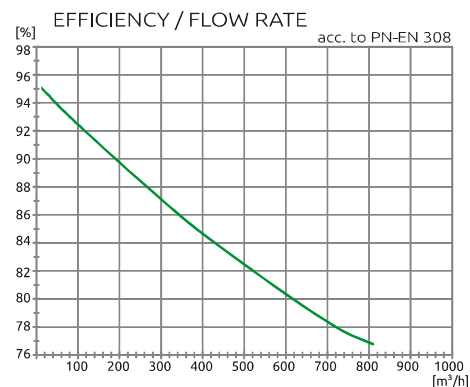

IN STANDARD

OPTIONS
ADDITIONAL

WANAS 815V HI-TECH — WANAS 815H HI-TECH

Wanas **HI-TECH series** air handling units are fabricated with safe and non flammable materials. What more they are water proof and painted with poliester paint to keep your unit more hygiene and durability.

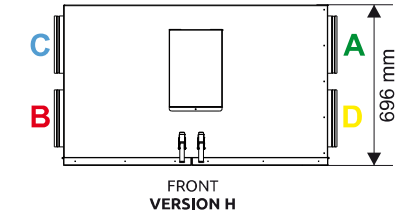
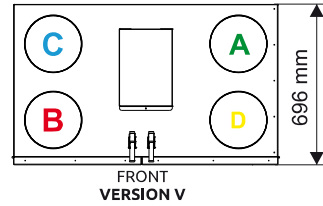
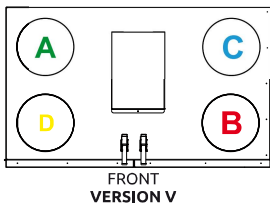
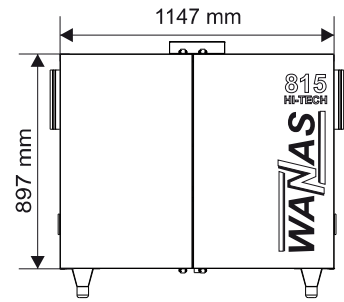
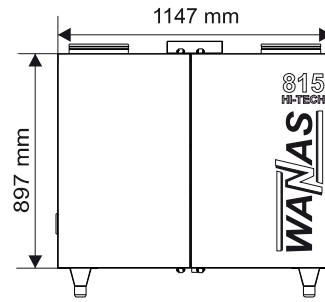

- A - external fresh air
- B - air extraction from rooms
- C - air supply to rooms
- D - spent air discharge to the outside

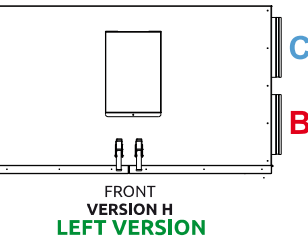

TECHNICAL DATA

		815V HI-TECH	815H HI-TECH
UEC (unit energy consumption) class	-		A
UEC for moderate climate	kWh/(m ² /rok)		-36,64
UEC for cool climate	kWh/(m ² /rok)		-73,76
UEC for warm climate	kWh/(m ² /rok)		-12,75
Max. flow rate (at 100 Pa)	m ³ /h		890
Acoustic power (gear I/ acc. to UE 1254/2014)	dB(A)		43/58
External static pressure (at nominal value)	Pa		180
Energy consumption	W		23-337
Pre-heater power	W		2 000
Power supply	V/Hz		230/50
Stub pipe diameter	mm		250
Max. efficiency acc. to UE 1254/2014, ΔT=13°C, at 140 m ³ /h, SWM	%		94,0
Efficiency acc. to UE 1254/2014, dT=13°C, SWM	%		83,1
Height	mm		897
Width	mm		1147
Depth	mm		696
Weight	kg		133,5
Filter class			ISO COARSE 75% + ePM 10 50%

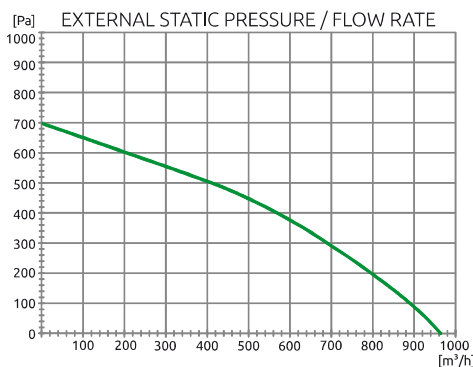
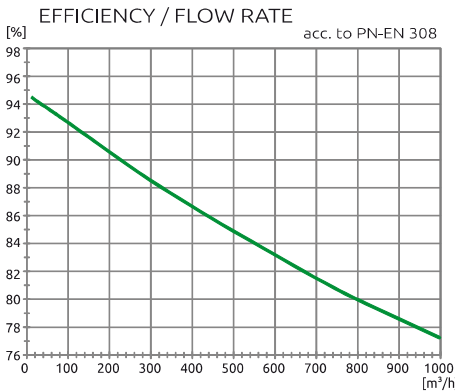

IN STANDARD



OPTIONS
ADDITIONAL

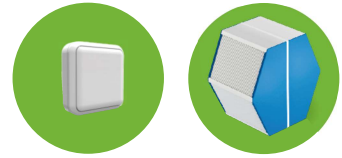

COMPARE OURS SOLUTIONS

	COMBO	BLACK	HI-TECH	BASIC	CLASSIC XF	CLASSIC
BUILT-IN WATER HEATER-COOLER	✓ ¹	—	—	—	—	—
BUILT-IN HUMIDIFIER	✓	—	—	—	—	—
HUMIDITY SENSOR AS STANDARD	✓	✓ ³	—	—	—	—
ILLUMINATED LOGO ON THE DOOR	—	—	✓	—	—	—
XF SYSTEM (FLOW BALANCING)	✓	✓ ²	✓	—	✓	—
SETTING THE FLOW RATE IN m ³ /h	✓	✓ ²	✓	—	✓	—
PREVIEW OF THE FLOW RATE IN m ³ /h	✓	✓ ²	✓	—	✓	—
POSSIBILITY OF CONNECTING WITH A FREON COOLER	✓	✓ ²	✓	✓	✓	—
MODBUS RTU	✓	✓	✓	✓	✓	—
HYBRID SYSTEM	—	—	✓	✓	—	—
INTERIOR PAINTED WITH POLYESTER PAINT	✓	—	✓	✓	—	—
BUILT-IN WI-FI MODULE	—	✓ ³	—	—	—	—
ONLINE CONTROL	OPTION	✓ ³	✓	OPTION	OPTION	OPTION
SMART HEATER	✓	✓	✓	✓	✓	✓
REDUCED NOISE ON THE AIR SUPPLY	✓	✓	✓	✓	✓	✓
STAINLESS STEEL DRIP TRAY	✓	—	✓	✓	✓	✓
NON-FLAMMABLE INSULATION OF THE AIR HANDLING UNIT	✓	✓	✓	✓	✓	✓
WALL MOUNT ⁴	✓	✓	✓	✓	✓	✓
AUTOMATYCZNY BYPASS 100%	✓	✓	✓	✓	✓	✓
WEEKLY PROGRAMME	✓	✓	✓	✓	✓	✓
PARTY MODE	✓	✓	✓	✓	✓	✓
FIREPLACE MODE	✓	✓	✓	✓	✓	✓
HOLIDAY MODE	✓	✓ ²	✓	✓	✓	✓
FILTER REPLACEMENT ALERT MODE	✓	✓	✓	✓	✓	✓
FULL-RANGE EFFICIENCY ADJUSTMENT	✓	✓	✓	✓	✓	✓
CONNECTION TO THE COOLER	✓	✓ ²	✓	✓	✓	✓
CONNECTION TO GWC	✓	✓ ²	✓	✓	✓	✓
CONNECTION TO THE SECONDARY HEATER	✓	✓ ²	✓	✓	✓	✓
COMPATIBILITY WITH EXTERNAL SENSORS	✓	✓ ²	✓	✓	✓	✓
POSSIBLE INTEGRATION WITH THE ALARM	✓	✓ ²	✓	✓	✓	✓
OCHRONA ANTYZAMROŻENIOWA	✓	✓	✓	✓	✓	✓
FREEZE PROTECTION	✓	✓	✓	✓	✓	✓
ALUMINUM EXCHANGER	✓	✓	—	—	✓	✓
DISPLAY V3	—	✓	—	—	—	—
DISPLAY V2	✓	✓	✓	✓	✓	—
DISPLAY V1	—	—	—	—	—	✓
BODY MADE OF POLYPROPYLENE	—	✓	—	—	—	—

¹ It is standard in COMBO PRESTIGE.

² It is standard in BLACK XF with Display V2.

³ It is standard in BLACK with Display V3.

⁴ Does not apply to control panels: 815 HI-TECH, 815 BASIC, 900H and 1300H

WANAS AIR HANDLING UNITS **CLASSIC XF**



AIR HANDLING UNIT **WANAS 555H XF**

SEE INSIDE

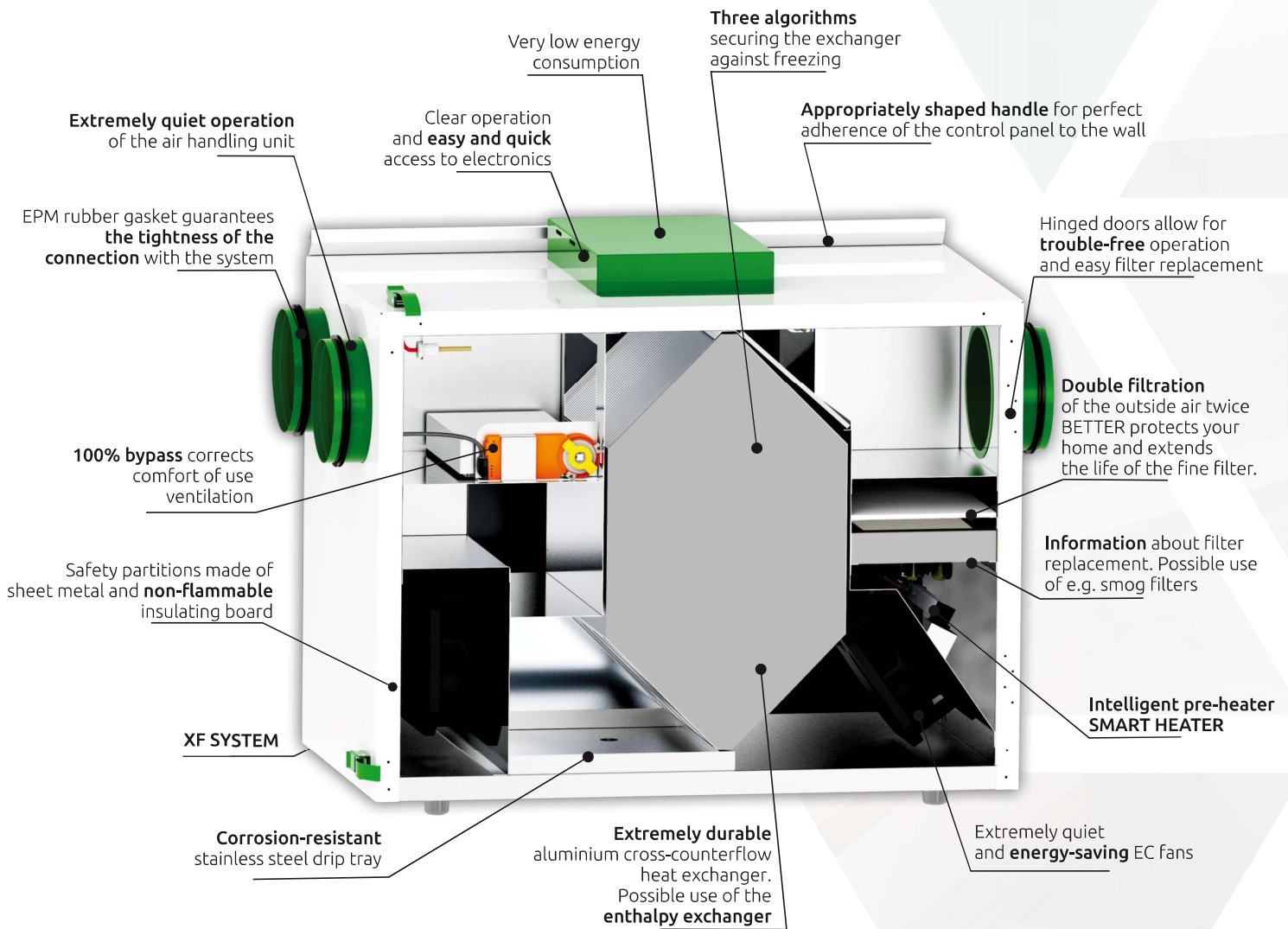

WANAS 355V XF - WANAS 355H XF



Air Flow auto balancing system is available in the most popular CLASSIC series air handling units. The units is characterized by exceptionally quiet operation, high thermal efficiency and easy operation, and the **XF system** guarantees higher comfort and energy savings.

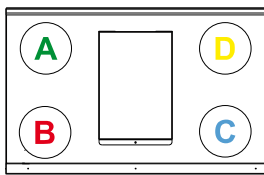
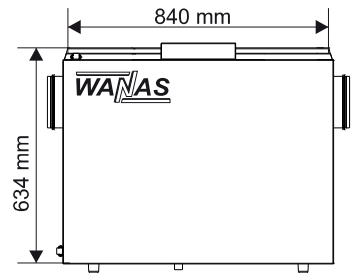
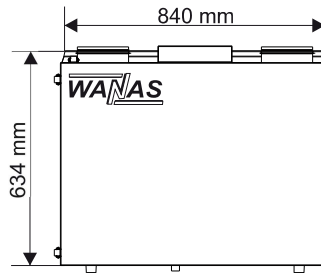

FRONT
VERSION V

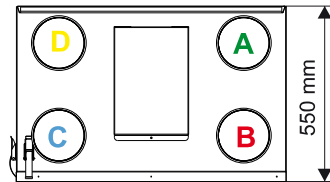

FRONT
VERSION V

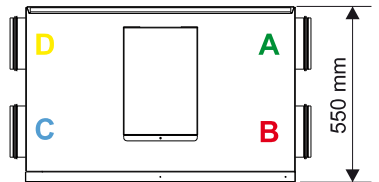

FRONT
VERSION H

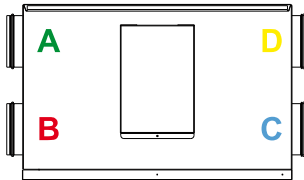

FRONT
VERSION H
LEFT VERSION

- A - external fresh air
- B - air extraction from rooms
- C - air supply to rooms
- D - spent air discharge to the outside

TECHNICAL DATA

		355V XF	355H XF
UEC (unit energy consumption) class	-		A
UEC for moderate climate	kWh/(m ² /year)		-37,3
UEC for cool climate	kWh/(m ² /year)		-74,21
UEC for warm climate	kWh/(m ² /year)		-13,53
Max. flow rate (at 100 Pa)	m ³ /h		420
Acoustic power (gear I/ acc. to UE 1254/2014)	dB(A)		38/48
External static pressure (at 350 m ³ /h)	Pa		234
Energy consumption	W		16-178
Pre-heater power	W		500
Power supply	V/Hz		230/50
Stub pipe diameter	mm		160
Max. efficiency acc. to UE 1254/204, ΔT=13°C, at 100 m ³ /h, SWM	%		89,3
Efficiency acc. to UE 1254/2014, dT=13°C, SWM	%		82,3
Height	mm		634
Width	mm		840
Depth	mm		550
Weight	kg		65
Filter class			ISO COARSE 75% + ePM 10 50%

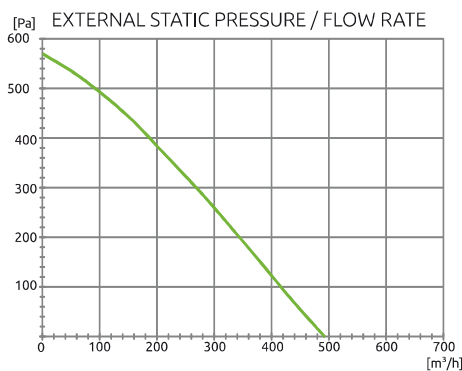
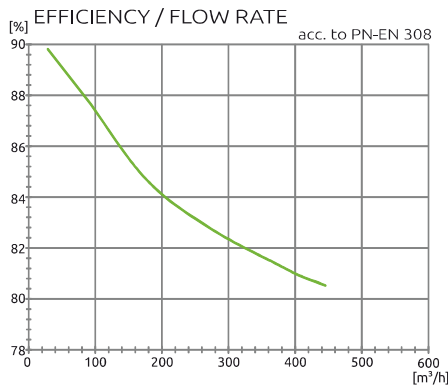

IN STANDARD



OPTIONS
ADDITIONAL



WANAS 555V XF — WANAS 555H XF

CLASSIC XF series are equipped with touch controller DISPLAY V2 which is showing current flow rate in m³/h for supply and exhaust air, so that the user can observe the balancing of flows on the fans.

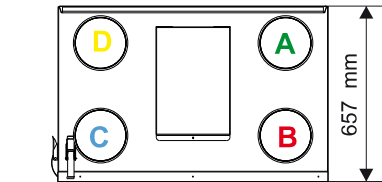
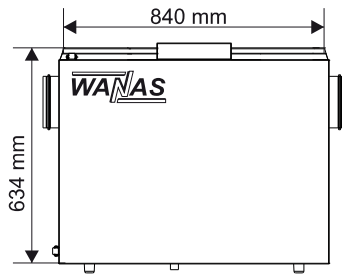
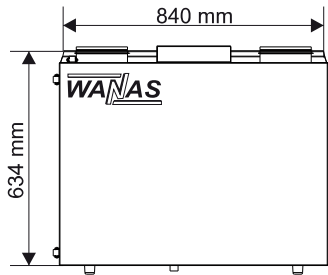

FRONT
VERSION V

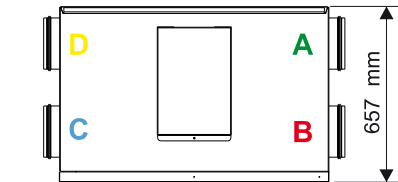

FRONT
VERSION H

- A - external fresh air
- B - air extraction from rooms
- C - air supply to rooms
- D - spent air discharge to the outside

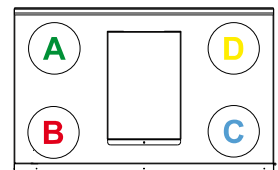
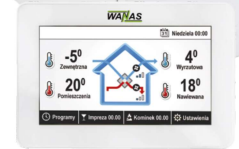

FRONT
VERSION V

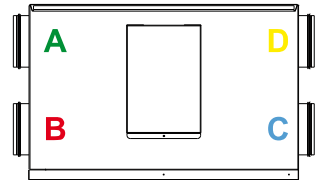

FRONT
VERSION H
LEFT VERSION

TECHNICAL DATA

555V XF
555H XF

UEC (unit energy consumption) class	-	A
UEC for moderate climate	kWh/(m ² /year)	-36,67
UEC for cool climate	kWh/(m ² /year)	-73,37
UEC for warm climate	kWh/(m ² /year)	-13,02
Max. flow rate (at 100 Pa)	m ³ /h	595
Acoustic power (gear I/ acc. to UE 1254/2014)	dB(A)	40/58
External static pressure (at 550 m ³ /h)	Pa	166
Energy consumption	W	26-265
Pre-heater power	W	500
Power supply	V/Hz	230/50
Stub pipe diameter	mm	200
Max. efficiency acc. to UE 1254/2014, ΔT=13°C, at 100 m ³ /h, SWM	%	90,7
Efficiency acc. to UE 1254/2014, dT=13°C, SWM	%	81,5
Height	mm	634
Width	mm	840
Depth	mm	657
Weight	kg	71,3
Filter class		ISO COARSE 75% + ePM 10 50%

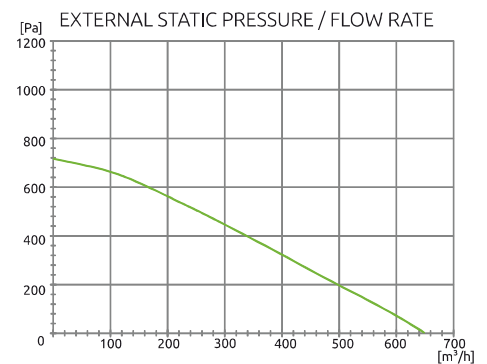
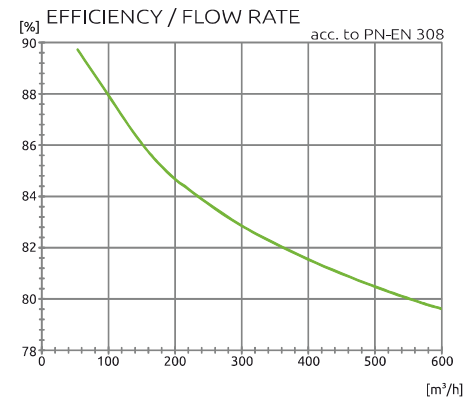

IN STANDARD

OPTIONS
ADDITIONAL

WANAS AIR HANDLING UNITS **CLASSIC**



AIR HANDLING UNIT **WANAS 350V/3**

SEE INSIDE

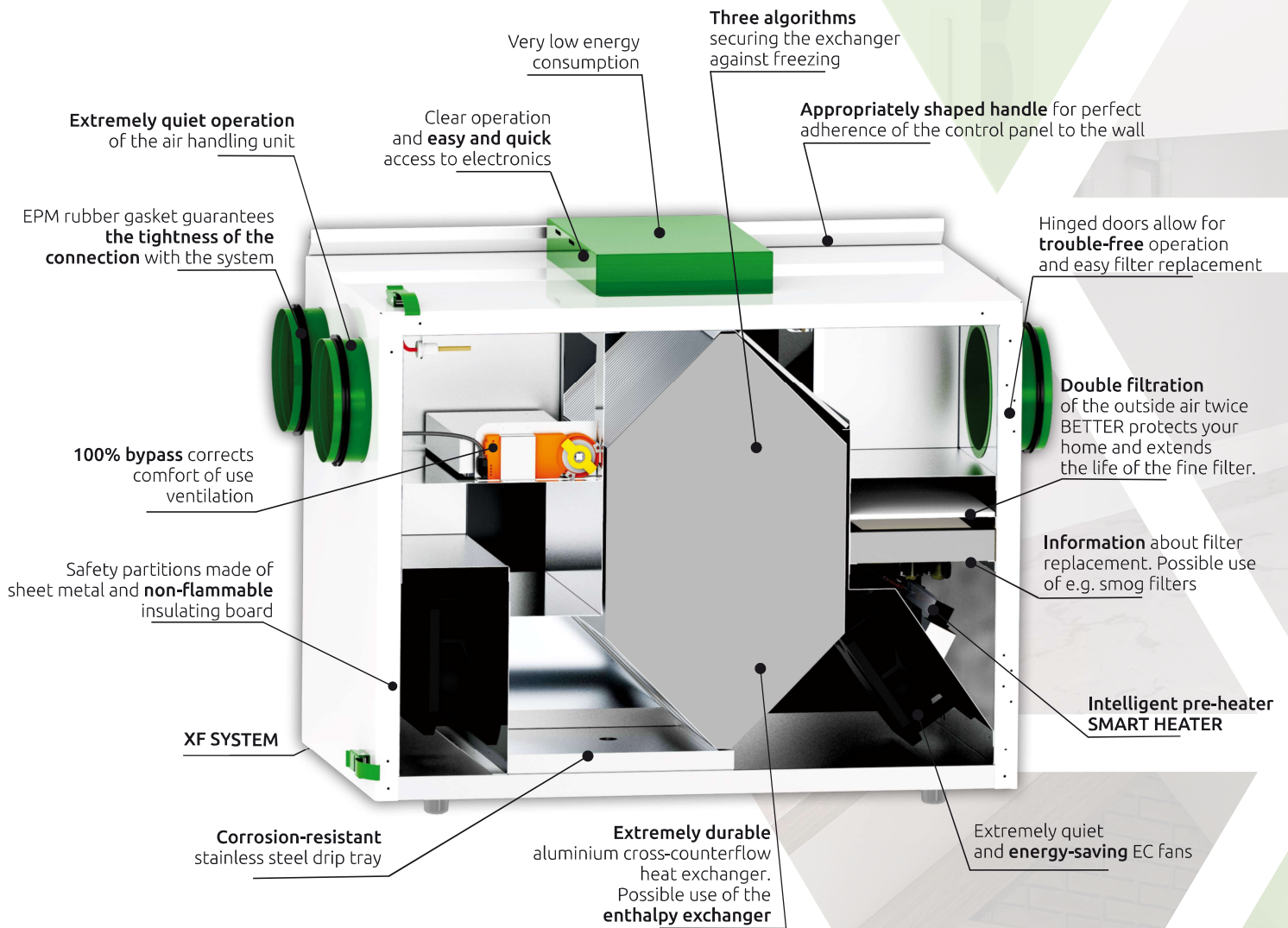

Compatible with temperature and humidity sensor



WANAS 350 V/3 - WANAS 350 H/3



All WANAS air handling units are isolated with rubber based insulation materials which provides good thermal isolation and non flammability. Due to its closed-cell property isolation will not absorb the moisture.

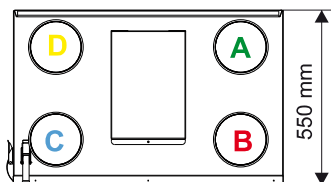
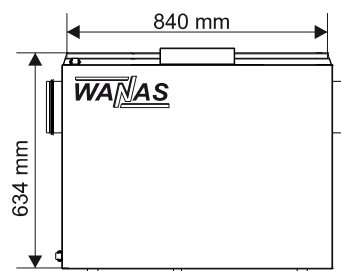
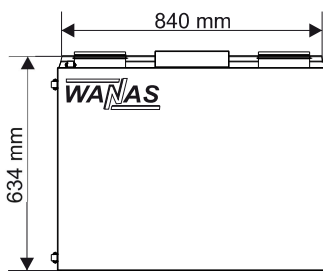

FRONT
VERSION V

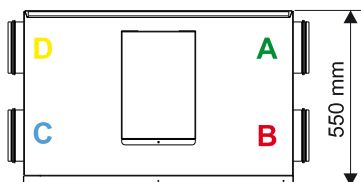

FRONT
VERSION H

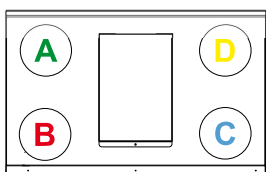

FRONT
VERSION V

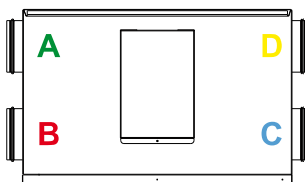

FRONT
VERSION H
LEFT VERSION

- A - external fresh air
- B - air extraction from rooms
- C - air supply to rooms
- D - spent air discharge to the outside

TECHNICAL DATA

	350 V/3	350 H/3
UEC (unit energy consumption) class	-	A
UEC for moderate climate	kWh/(m ² /year)	-37,3
UEC for cool climate	kWh/(m ² /year)	-74,21
UEC for warm climate	kWh/(m ² /year)	-13,53
Max. flow rate (at 100 Pa)	m ³ /h	420
Acoustic power (gear I/ acc. to UE 1254/2014)	dB(A)	38/48
External static pressure (at 350 m ³ /h)	Pa	234
Energy consumption	W	16-178
Pre-heater power	W	500
Power supply	V/Hz	230/50
Stub pipe diameter	mm	160
Max. efficiency acc. to UE 1254/204, ΔT=13°C, at 100 m ³ /h, SWM	%	89,3
Efficiency acc. to UE 1254/2014, dT=13°C, SWM	%	82,3
Height	mm	634
Width	mm	840
Depth	mm	550
Weight	kg	65
Filter class		ISO COARSE 75% + ePM 10 50%

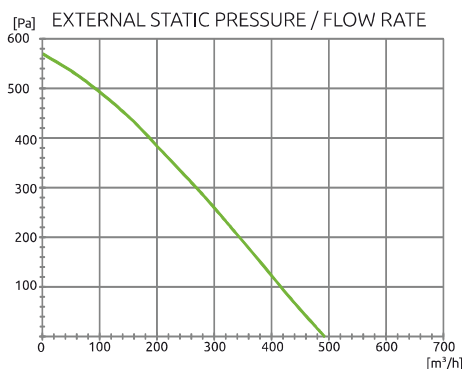
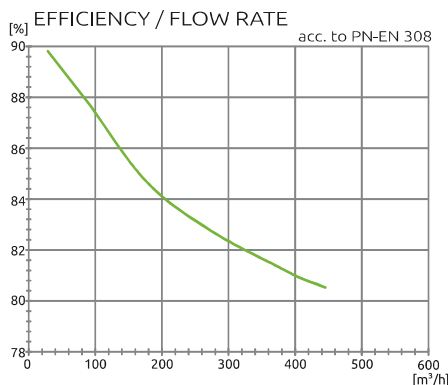

IN STANDARD



OPTIONS
ADDITIONAL

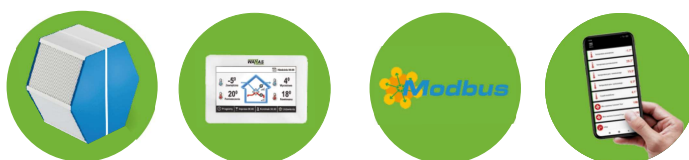

WANAS 550V/3 — WANAS 550H/3

Unit is equipped with smart touch controller including box for flush mounting, wall bracket and non-odour syphon. **All mentioned accessories are included in a price** of air handling unit.

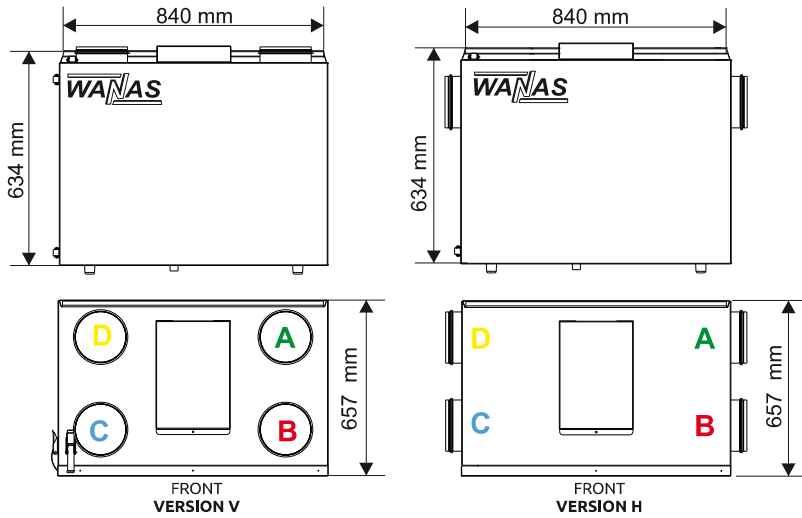

- A - external fresh air
- B - air extraction from rooms
- C - air supply to rooms
- D - spent air discharge to the outside

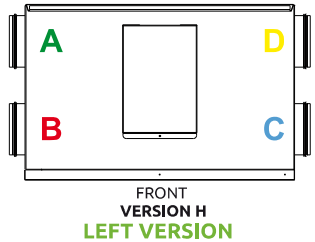
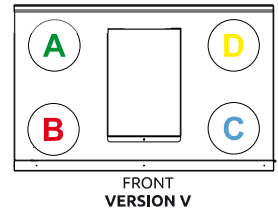

TECHNICAL DATA

550V/3
550H/3

UEC (unit energy consumption) class	-	A
UEC for moderate climate	kWh/(m ² /year)	-36,67
UEC for cool climate	kWh/(m ² /year)	-73,37
UEC for warm climate	kWh/(m ² /year)	-13,02
Max. flow rate (at 100 Pa)	m ³ /h	595
Acoustic power (gear I/ acc. to UE 1254/2014)	dB(A)	40/58
External static pressure (at 550 m ³ /h)	Pa	166
Energy consumption	W	26-265
Pre-heater power	W	500
Power supply	V/Hz	230/50
Stub pipe diameter	mm	200
Max. efficiency acc. to UE 1254/204, ΔT=13°C, at 100 m ³ /h, SWM	%	90,7
Efficiency acc. to UE 1254/2014, dT=13°C, SWM	%	81,5
Height	mm	634
Width	mm	840
Depth	mm	657
Weight	kg	71,3
Filter class		ISO COARSE 75% + ePM 10 50%

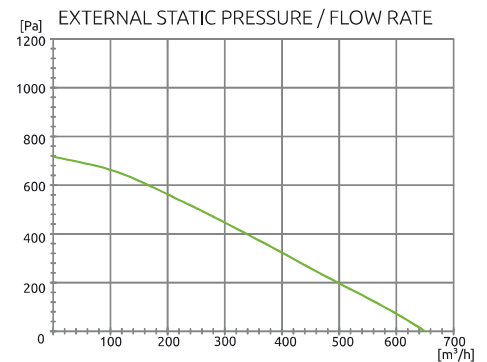
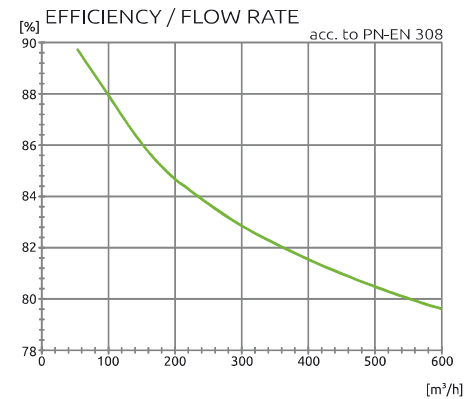

IN STANDARD

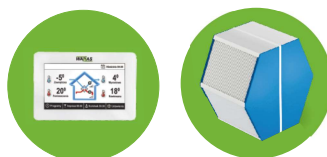

OPTIONAL

WANAS 345 — WANAS 800

Wall mounted air handling units are space saving devices, there can be installed in garage, boiler room or closet/dressing room. Under ceiling installation **gives extra space** for intended use.



WANAS 345



WANAS 800

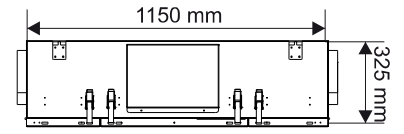
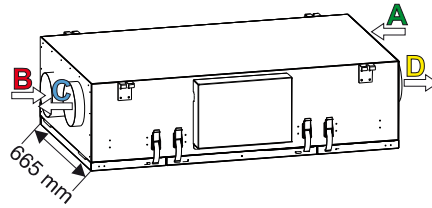

FRONT
WANAS 345

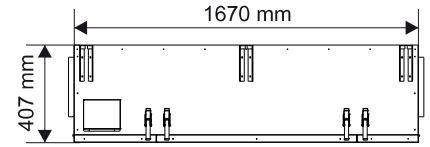
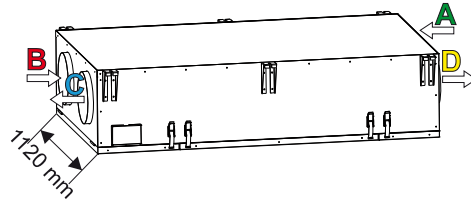

FRONT
WANAS 800

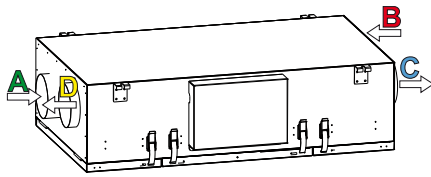

WANAS 345

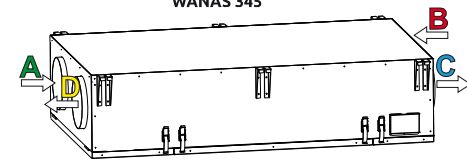

WANAS 800
LEFT VERSION

- A - external fresh air
- B - air extraction from rooms
- C - air supply to rooms
- D - spent air discharge to the outside

TECHNICAL DATA

	345	800
UEC (unit energy consumption) class	-	A
UEC for moderate climate	kWh/(m ² /year) -38,28	-38,22
UEC for cool climate	kWh/(m ² /year) -75,13	-75,03
UEC for warm climate	kWh/(m ² /year) -14,54	-14,51
Max. flow rate (at 100 Pa)	m ³ /h 380	900
Acoustic power (gear I/ acc. to UE 1254/2014)	dB(A) 37/49	40/61
External static pressure (at nominal value)	Pa 150	200
Energy consumption	W 16-170	24-335
Pre-heater power	W 500	2 000
Power supply	V/Hz 230/50	230/50
Stub pipe diameter	mm 160	250
Max. efficiency acc. to UE 1254/204, ΔT=13°C, at 120 m ³ /h, SWM	% 86,1	90,5
Efficiency acc. to UE 1254/2014, dT=13°C, SWM	% 82,1	81,9
Height	mm 325	407
Width	mm 1150	1670
Depth	mm 665	1120
Weight	kg 56,4	130
Filter class	ISO COARSE 75%	

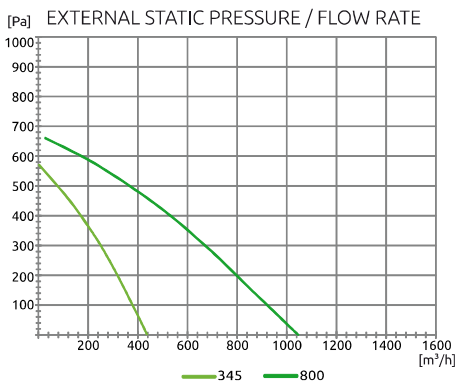
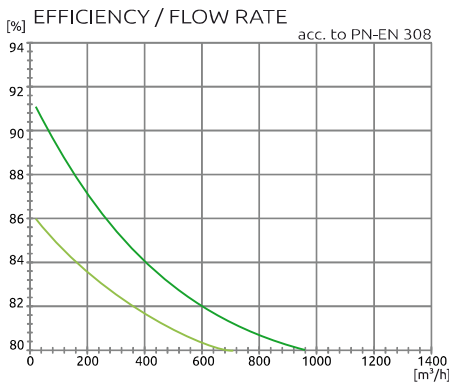

IN STANDARD

OPTIONS
ADDITIONAL

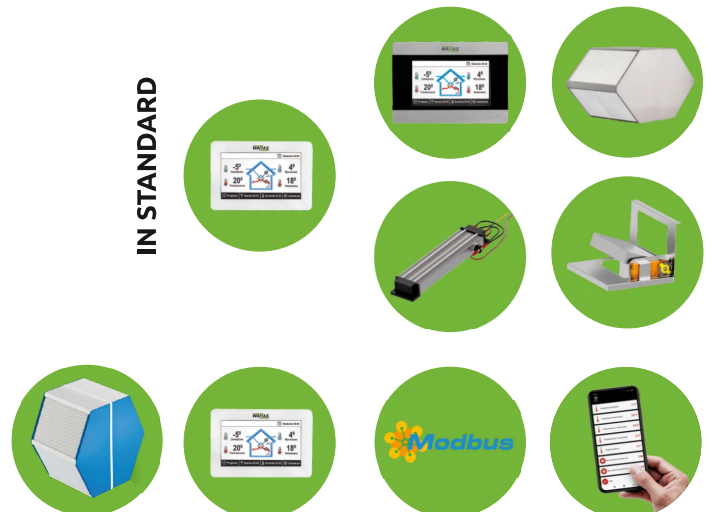

WANAS 900H — WANAS 1300H

Air handling units with higher efficiency can be installed in the public utility buildings, conducting service or educational activities and in industrial plants. What more the units are equipped with built-in internet module for remote control.

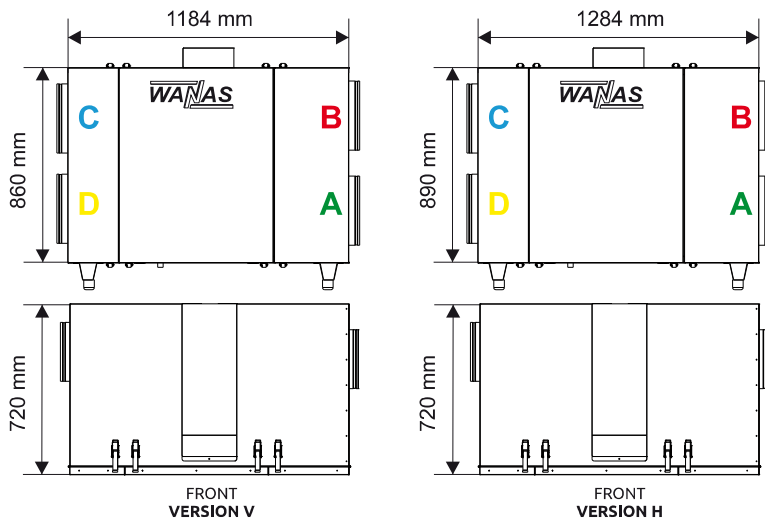

- A - external fresh air
- B - air extraction from rooms
- C - air supply to rooms
- D - spent air discharge to the outside

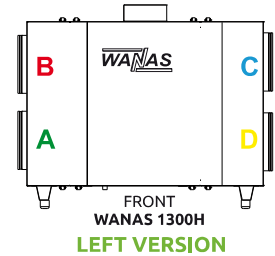
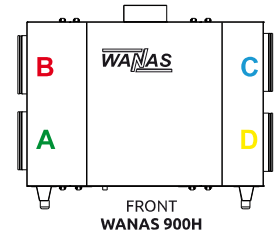

TECHNICAL DATA

		900H	1300H
UEC (unit energy consumption) class	-	A	A
UEC for moderate climate	kWh/(m ² /rok)	-39,47	-38,93
UEC for cool climate	kWh/(m ² /rok)	-77,46	-76,41
UEC for warm climate	kWh/(m ² /rok)	-15,08	-14,83
Max. flow rate (at 100 Pa)	m ³ /h	1 000	1 468
Acoustic power (gear I/ acc. to UE 1254/2014)	dB(A)	38/56	39/64
External static pressure (at nominal value)	Pa	230	240
Energy consumption	W	38-405	20-764
Pre-heater power	W	3 000	3 000
Power supply	V/Hz	230/50	230/50
Stub pipe diameter	mm	250	315
Max. efficiency acc. to UE 1254/204, ΔT=13°C, at 140 m ³ /h, SWM	%	95,3	95,3
Efficiency acc. to UE 1254/2014, dT=13°C, SWM	%	86,5	84,5
Height	mm	1080	1080
Width	mm	1184	1284
Depth	mm	720	720
Weight	kg	146	152
Filter class		ISO COARSE 75%	

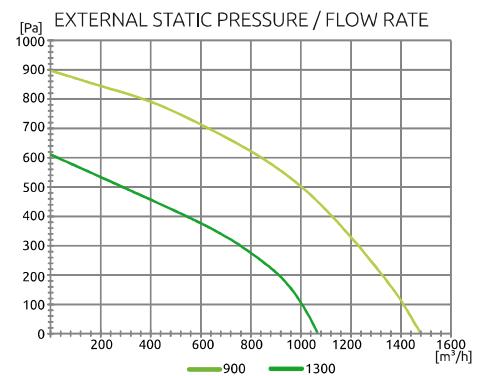
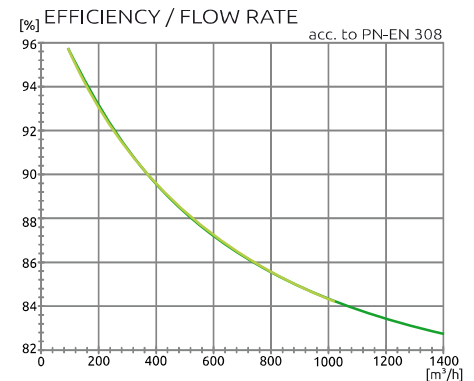

IN STANDARD

OPTIONS
ADDITIONAL

WANAS 250H

WANAS 250H air handling unit is a **unique, compact device**, new design provide an access to the motherboard even after installation close to the ceiling. This model is equipped with touch controller, high efficiency plastic heat exchanger and smart pre-heater of 0,5kW capacity as a standard.

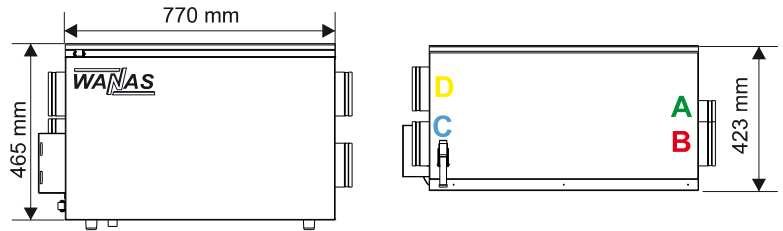

FRONT
BASIC VERSION

- A - external fresh air
- B - air extraction from rooms
- C - air supply to rooms
- D - spent air discharge to the outside

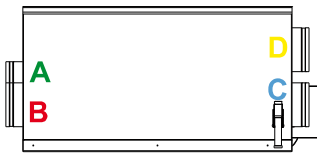

LEFT VERSION

TECHNICAL DATA

		250H
UEC (unit energy consumption) class	-	A
UEC for moderate climate	kWh/(m ² /rok)	-35,87
UEC for cool climate	kWh/(m ² /rok)	-73,27
UEC for warm climate	kWh/(m ² /rok)	-11,82
Max. flow rate (at 100 Pa)	m ³ /h	257
Acoustic power (gear I/ acc. to UE 1254/2014)	dB(A)	41/57
External static pressure (at 250 m ³ /h)	Pa	115
Energy consumption	W	20-152
Pre-heater power	W	500
Power supply	V/Hz	230/50
Stub pipe diameter	mm	125
Max. efficiency acc. to UE 1254/204, ΔT=13°C, at 120 m ³ /h, SWM	%	87,2
Efficiency acc. to UE 1254/2014, dT=13°C, SWM	%	84,2
Height	mm	465
Width	mm	770
Depth	mm	423
Weight	kg	43,5
Filter class		ISO COARSE 75% + ePM 10 50%

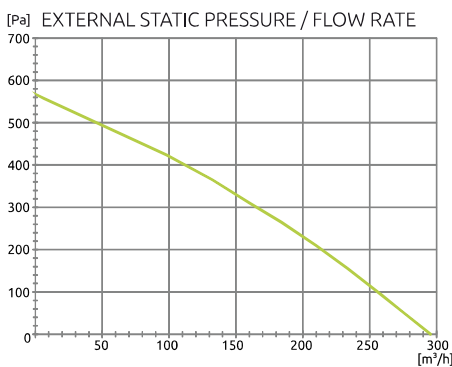
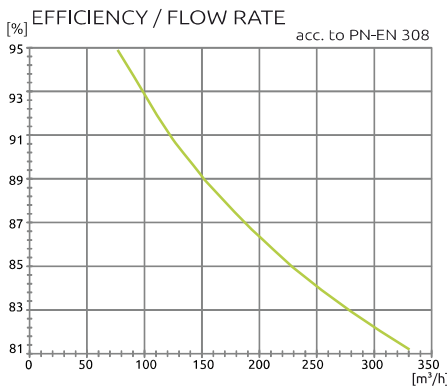

IN STANDARD

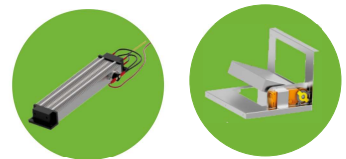

OPTIONS
ADDITIONAL

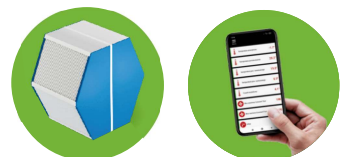

UMECTO 1300 UNI — UMECTO 600 UNI

New solution allows humidifier to be connected **to existing ventilation system** and to the any air handling unit available on the market. Humidifier shall be installed on the supply duct and it is an independent unit. WANAS UMECTO UNI is controlled by the top-mounted controller, which is included in the price of every WANAS UMECTO UNI unit. Thanks to wireless miniControl sensor, the **humidity will be controlled easily and automatically.**



TECHNICAL DATA

		UMECTO 600 UNI	UMECTO 1300 UNI
Max. flow rate	m ³ /h	600	1300
Energy consumption	W	2-18	2-18
Power supply	V/Hz	230/50	230/50
Stub pipe diameter	mm	200	315
Water connector diameter	cal	3/4	3/4
Heater power	W	1 000	2 000
Maximum water consumption*	l/h	2,8	5,6
Air resistance at 200 m ³ /h	Pa	7	11
Water pressure	MPa	0,15-0,6	0,15-0,6
Water temperature	°C	5-20	5-20
Water hardness	max. mg CaCO ₃	200	200
Height	mm	607	937
Width	mm	455	455
Depth	mm	450	450
Weight	kg	25	36

*at a water pressure of 3 bar, at maximum valve settings



UMECTO humidifier is based on the natural process of water evaporation, this process is the most **beneficial for our health and it is natural.** It helps to keep humidity in the range of 40-45%, the adequate level of humidity during winter time/ heating season has a positive effect on the skin, eyes and prevents the mucus membrane from drying out. Protects wooden furnitures, floors and parquets from damage and drying out. Low humidity dries the outer layer of our skin leading to itchiness, cracking and dermatological problems.

Another benefit of using WANAS UMECTO humidifier is **secondary purification** done by moist evaporation mat, which catch pollen, dust mites, and other particulates automatically are flashed direct to the sewage drain.



In standard wireless humidity sensor **miniControl**

INCREASE THE HUMIDITY - BREATHE COMFORTABLE!

The efficient WANAS UMECTO humidifier allows you to maintain the humidity in the building at the level of 40-50%. Its control is carried out using the recuperator controller and is fully automatic.

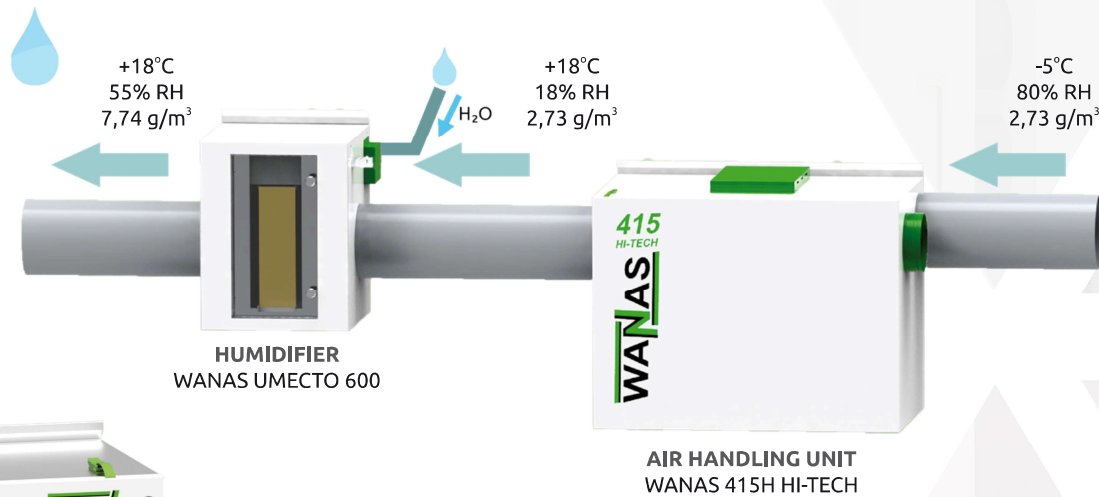

HUMIDIFIER

TECHNICAL DATA

		UMECTO 600	UMECTO 1300
Max. flow rate	m ³ /h	600	1300
Energy consumption	W	15	15
Power supply	V/Hz	230/50	230/50
Stub pipe diameter	mm	200	315
Water connector diameter	cal	3/4	3/4
Heater power	W	1 000	2 000
Maximum water consumption*	l/h	2,8	5,6
Air resistance at 200 m ³ /h	Pa	7	11
Water pressure	MPa	0,15-0,6	0,15-0,6
Water temperature	Min/max	5-20	5-20
Water hardness	max. mg CaCO ₃	200	200
Height	mm	494	824
Width	mm	455	455
Depth	mm	452	452
Weight	kg	25	36

*at a water pressure of 3 bar, at maximum valve settings

UMECTO 600





WATER HEATER/COOLER

TECHNICAL DATA

		426	444
Recommended flow up to	m ³ /h	600	1300
Efficiency up to	kW	3,1	7,3
Stub pipe diameter	mm	200	315
Height	mm	402	625
Width	mm	683	484
Depth	mm	550	659
Weight	kg	35,85	45,5
Filter class		ISO COARSE 75%	-
Stub pipe layout		universal	horizontal



Air handling units WANAS

	EAN	Code	Name
	5903890751944	RE-250 H	Air handling unit WANAS 250H
	5903890752040	RE-250 H/L	Air handling unit WANAS 250H - left version
	5903890751968	RE-250 H_E	Air handling unit WANAS 250H with enthalpy exchanger
	5903890752057	RE-250 H/L_E	Air handling unit WANAS 250H with enthalpy exchanger - left version
	5903890750343	RE-345	Air handling unit WANAS 345
	5903890752088	RE-345/L	Air handling unit WANAS 345 - left version
	5903890750350	RE-345_SV2	Air handling unit WANAS 345 with Display V2
	5903890752095	RE-345/L_SV2	Air handling unit WANAS 345 with Display V2 - left version
	5903890752866	RE-200V	Air handling unit WANAS BLACK 200V with Display V3
	5903890752873	RE-200V_E	Air handling unit WANAS BLACK 200V with enthalpy exchanger and Display V3
	5903890752880	RE-200V_XF	Air handling unit WANAS BLACK 200V with Display V2
	5903890752897	RE-200V_XF_E	Air handling unit WANAS BLACK 200V with enthalpy exchanger and Display V2
	5903890752903	RE-300V	Air handling unit WANAS BLACK 300V with Display V3
	5903890752910	RE-300V_E	Air handling unit WANAS BLACK 300V with enthalpy exchanger and Display V3
	5903890752927	RE-300V_XF	Air handling unit WANAS BLACK 300V with Display V2
	5903890752934	RE-300V_XF_E	Air handling unit WANAS BLACK 300V with enthalpy exchanger and Display V2

Air handling units WANAS

EAN	Code	Name
-----	------	------

5903890750268	RE-350 H/3	Air handling unit WANAS 350H/3
5903890752101	RE-350 H/3/L	Air handling unit WANAS 350H/3 - left version

5903890750275	RE-350 H/3_SV2	Air handling unit WANAS 350H/3 with Display V2
5903890752132	RE-350 H/3/L_SV2	Air handling unit WANAS 350H/3 with Display V2 - left version



5903890750282	RE-350 H/3_E	Air handling unit WANAS 350H/3 with enthalpy exchanger
5903890752118	RE-350 H/3/L_E	Air handling unit WANAS 350H/3 with enthalpy exchanger - left version

5903890750299	RE-350 H/3_SV2_E	Air handling unit WANAS 350H/3 with Display V2 and enthalpy exchanger
5903890752125	RE-350 H/3/L_SV2_E	Air handling unit WANAS 350H/3 with Display V2 and enthalpy exchanger - left version

5903890750305	RE-350 V/3	Air handling unit WANAS 350V/3
5903890752149	RE-350 V/3/L	Air handling unit WANAS 350V/3 - left version

5903890750312	RE-350 V/3_SV2	Air handling unit WANAS 350V/3 with Display V2
5903890752170	RE-350 V/3/L_SV2	Air handling unit WANAS 350V/3 with Display V2 - left version



5903890750329	RE-350 V/3_E	Air handling unit WANAS 350V/3 with enthalpy exchanger
5903890752156	RE-350 V/3/L_E	Air handling unit WANAS 350V/3 with enthalpy exchanger - left version

5903890750336	RE-350 V/3_SV2_E	Air handling unit WANAS 350V/3 with Display V2 and enthalpy exchanger
5903890752163	RE-350 V/3/L_SV2_E	Air handling unit WANAS 350V/3 with Display V2 and enthalpy exchanger - left version

Air handling units WANAS

	EAN	Code	Name
	5903890752668	RE-355 H_XF	Air handling unit WANAS 355 H_XF
	5903890752767	RE-355 H_XF/L	Air handling unit WANAS 355 H_XF - left version
	5903890752675	RE-355 H_XF_E	Air handling unit WANAS 355 H_XF with enthalpy exchanger
	5903890752835	RE-355 H_XF_E/L	Air handling unit WANAS 355 H_XF with enthalpy exchanger - left version
	5903890752682	RE-355 V_XF	Air handling unit WANAS 355 V_XF
	5903890752774	RE-355 V_XF/L	Air handling unit WANAS 355 V_XF - left version
	5903890752699	RE-355 V_XF_E	Air handling unit WANAS 355 V_XF with enthalpy exchanger
	5903890752842	RE-355 V_XF_E/L	Air handling unit WANAS 355 V_XF with enthalpy exchanger - left version
	5903890750077	RE-415 H	Air handling unit WANAS 415H BASIC
	5903890752187	RE-415 H/L	Air handling unit WANAS 415H BASIC - left version
	5903890750190	RE-415 H_E	Air handling unit WANAS 415H BASIC with enthalpy exchanger
	5903890752194	RE-415 H/L_E	Air handling unit WANAS 415H BASIC with enthalpy exchanger - left version
	5903890750015	RE-415 H HI	Air handling unit WANAS 415H HI-TECH
	5903890752200	RE-415 H HI/L	Air handling unit WANAS 415H HI-TECH - left version
	5903890750138	RE-415 H HI_E	Air handling unit WANAS 415H HI-TECH with enthalpy exchanger
	5903890752217	RE-415 H HI/L_E	Air handling unit WANAS 415H HI-TECH with enthalpy exchanger - left version

Air handling units WANAS

	EAN	Code	Name	
	5903890750060	RE-415 V	Air handling unit WANAS 415V BASIC	
	5903890752224	RE-415 V/L	Air handling unit WANAS 415V BASIC - left version	
	5903890750183	RE-415 V_E	Air handling unit WANAS 415V BASIC with enthalpy exchanger	
	5903890752231	RE-415 V/L_E	Air handling unit WANAS 415V BASIC with enthalpy exchanger - left version	
	5903890750008	RE-415 V HI	Air handling unit WANAS 415V HI-TECH	
	5903890752248	RE-415 V HI/L	Air handling unit WANAS 415V HI-TECH - left version	
	5903890750121	RE-415 V HI_E	Air handling unit WANAS 415V HI-TECH with enthalpy exchanger	
	5903890752255	RE-415 V HI/L_E	Air handling unit WANAS 415V HI-TECH with enthalpy exchanger - left version	
		5903890752972	RE- 430_LIGHT_XF	Air handling unit WANAS 430 LIGHT with XF SYSTEM
		5903890753085	RE- 430_LIGHT_XF/L	Air handling unit WANAS 430 LIGHT with XF SYSTEM - left version
5903890753016		RE- 630_LIGHT_XF	Air handling unit WANAS 430 LIGHT with XF SYSTEM	
5903890753047		RE- 630_LIGHT_XF/L	Air handling unit WANAS 430 LIGHT with XF SYSTEM - left version	
		5903890752989	RE- 430_PRESTIGE_XF	Air handling unit WANAS 430 LIGHT with XF SYSTEM
		5903890753078	RE- 430_PRESTIGE_XF/L	Air handling unit WANAS 430 LIGHT with XF SYSTEM - left version
	5903890753023	RE- 630_PRESTIGE_XF	Air handling unit WANAS 430 LIGHT with XF SYSTEM	
	5903890753030	RE- 630_PRESTIGE_XF/L	Air handling unit WANAS 430 LIGHT with XF SYSTEM - left version	

Air handling units WANAS

EAN	Code	Name
5903890750367	RE-550 H/3	Air handling unit WANAS 550H/3
5903890752262	RE-550 H/3/L	Air handling unit WANAS 550H/3 - left version
5903890750374	RE-550 H/3_SV2	Air handling unit WANAS 550H/3 with Display V2
5903890752293	RE-550 H/3/L_SV2	Air handling unit WANAS 550H/3 with Display V2 - left version
5903890750381	RE-550 H/3_E	Air handling unit WANAS 550H/3 with enthalpy exchanger
5903890752279	RE-550 H/3/L_E	Air handling unit WANAS 550H/3 with enthalpy exchanger - left version
5903890750398	RE-550 H/3_SV2_E	Air handling unit WANAS 550H/3 with Display V2 with enthalpy exchanger
5903890752286	RE-550 H/3/L_SV2_E	Air handling unit WANAS 550H/3 with Display V2 and enthalpy exchanger - left version
5903890750404	RE-550 V/3	Air handling unit WANAS 550V/3
5903890752309	RE-550 V/3/L	Air handling unit WANAS 550V/3 - left version
5903890750411	RE-550 V/3_SV2	Air handling unit WANAS 550V/3 with Display V2
5903890752330	RE-550 V/3/L_SV2	Air handling unit WANAS 550V/3 with Display V2 - left version
5903890750428	RE-550 V/3_E	Air handling unit WANAS 550V/3 with enthalpy exchanger
5903890752316	RE-550 V/3/L_E	Air handling unit WANAS 550V/3 with enthalpy exchanger - left version
5903890750435	RE-550 V/3_SV2_E	Air handling unit WANAS 550V/3 with Display V2 and enthalpy exchanger
5903890752323	RE-550 V/3/L_SV2_E	Air handling unit WANAS 550V/3 with Display V2 and enthalpy exchanger - left version
5903890752712	RE-555 H_XF	Air handling unit WANAS 555 H_XF with Display V2
5903890752750	RE-555 H_XF/L	Air handling unit WANAS 555 H_XF with Display V2 - left version
5903890752705	RE-555 H_XF_E	Air handling unit WANAS 555 H_XF with Display V2 and enthalpy exchanger
5903890752859	RE-555 H_XF_E/L	Air handling unit WANAS 555 H_XF with Display V2 and enthalpy exchanger - left version



Air handling units WANAS

EAN	Code	Name
-----	------	------



5903890752729	RE-555 V_XF	Air handling unit WANAS 555 V_XF with Display V2
5903890752743	RE-555 V_XF/L	Air handling unit WANAS 555 V_XF with Display V2 - left version
5903890752736	RE-555 V_XF_E	Air handling unit WANAS 555 V_XF with Display V2 with enthalpy exchanger
5903890752859	RE-555 V_XF_E/L	Air handling unit WANAS 555 V_XF with Display V2 and enthalpy exchanger - left version



5903890750091	RE-615 H	Air handling unit WANAS 615H BASIC
5903890752347	RE-615 H/L	Air handling unit WANAS 615H BASIC - left version
5903890750213	RE-615 H_E	Air handling unit WANAS 615H BASIC with enthalpy exchanger
5903890752354	RE-615 H/L_E	Air handling unit WANAS 615H BASIC with enthalpy exchanger - left version
5903890750039	RE-615 H HI	Air handling unit WANAS 615H HI-TECH
5903890752361	RE-615 H HI/L	Air handling unit WANAS 615H HI-TECH - left version
5903890750152	RE-615 H HI_E	Air handling unit WANAS 615H HI-TECH with enthalpy exchanger
5903890752378	RE-615 H HI/L_E	Air handling unit WANAS 615H HI-TECH with enthalpy exchanger - left version



5903890750084	RE-615 V	Air handling unit WANAS 615V BASIC
5903890752385	RE-615 V/L	Air handling unit WANAS 615V BASIC - left version
5903890750206	RE-615 V_E	Air handling unit WANAS 615V BASIC with enthalpy exchanger
5903890752392	RE-615 V/L_E	Air handling unit WANAS 615V BASIC with enthalpy exchanger - left version
5903890750022	RE-615 V HI	Air handling unit WANAS 615V HI-TECH
5903890752408	RE-615 V HI/L	Air handling unit WANAS 615V HI-TECH - left version
5903890750145	RE-615 V HI_E	Air handling unit WANAS 615V HI-TECH with enthalpy exchanger
5903890752415	RE-615 V HI/L_E	Air handling unit WANAS 615V HI-TECH with enthalpy exchanger - left version

Air handling units WANAS

EAN	Code	Name
5903890750114	RE-815 H	Air handling unit WANAS 815H BASIC
5903890752446	RE-815 H/L	Air handling unit WANAS 815H BASIC - left version
5903890750237	RE-815 H_E	Air handling unit WANAS 815H BASIC with enthalpy exchanger
5903890752453	RE-815 H/L_E	Air handling unit WANAS 815H BASIC with enthalpy exchanger - left version
5903890750053	RE-815 H HI	Air handling unit WANAS 815H HI-TECH
590389075460	RE-815 H HI/L	Air handling unit WANAS 815H HI-TECH - left version
5903890750176	RE-815 H HI_E	Air handling unit WANAS 815H HI-TECH with enthalpy exchanger
5903890752477	RE-815 H HI/L_E	Air handling unit WANAS 815H HI-TECH with enthalpy exchanger - left version
5903890750107	RE-815 V	Air handling unit WANAS 815V BASIC
5903890752484	RE-815 V/L	Air handling unit WANAS 815V BASIC - left version
5903890750220	RE-815 V_E	Air handling unit WANAS 815V BASIC with enthalpy exchanger
5903890752491	RE-815 V/L_E	Air handling unit WANAS 815V BASIC with enthalpy exchanger - left version
5903890750046	RE-815 V HI	Air handling unit WANAS 815V HI-TECH
5903890752507	RE-815 V HI/L	Air handling unit WANAS 815V HI-TECH - left version
5903890750169	RE-815 V HI_E	Air handling unit WANAS 815V HI-TECH with enthalpy exchanger
5903890752514	RE-815 V HI/L_E	Air handling unit WANAS 815V HI-TECH with enthalpy exchanger - left version



Air handling units WANAS

EAN

Code

Name



5903890750459

RE-800_SV2

Air handling unit WANAS 800 with Display V2

5903890752439

RE-800/L_SV2

Air handling unit WANAS 800 with Display V2 - left version



5903890750473

RE-900 H_SV2

Air handling unit WANAS 900H with Display V2

5903890752538

RE-900 H/L_SV2

Air handling unit WANAS 900H with Display V2 - left version

5903890750497

RE-1300 H_SV2

Air handling unit WANAS 1300H with Display V2

5903890752033

RE-1300 H/L_SV2

Air handling unit WANAS 1300H with Display V2 - left version



5903890750534

RE-NAWILŻACZ 600

Air humidifier WANAS UMECTO 600



5903890750541

RE-NAWILŻACZ 1300

Air humidifier WANAS UMECTO 1300



5903890752781

RE-NAWILŻACZ 600UNI

Universal air humidifier WANAS UMECTO 600 UNI









5903890750541





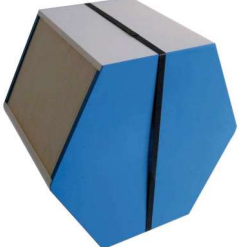



RE-NAWILŻACZ 1300UNI

Universal air humidifier WANAS UMECTO 1300 UNI

Air handling units WANAS

	EAN	Code	Name
	5903890750510	RE-CHŁODNICA 426	Water heater/Cooler WANAS 426
	5903890750527	RE-CHŁODNICA 444	Water exchanger WANAS 444
	5903890750527	RE-CHŁO FREON 334	Freon exchanger R32 WANAS 334 for WANAS COMBO
	5903890750732	RE-WYMIENNIK ENT.380	Enthalpy exchanger for WANAS 350
	5903890750749	RE-WYMIENNIK ENT.460	Enthalpy exchanger for WANAS 550
	5903890750756	RE-WYMIENNIK ENT.440	Enthalpy exchanger for WANAS 415
	5903890750763	RE-WYMIENNIK ENT.200	A set of enthalpy exchangers for WANAS 615
	5903890750770	RE-WYMIENNIK ENT.400	
	5903890750770	RE-WYMIENNIK ENT.400	A set of enthalpy exchangers for WANAS 815
	5903890750640	RE-STOJAK 250 MN/EPP	Stand for WANAS BLACK
	5903890751937	RE-STOJAK 250 H	Stand for WANAS 250H
	5903890750657	RE-STOJAK 350/415/GW	Stand for WANAS 350/355/415
	5903890750664	RE-STOJAK 550/615	Stand for WANAS 550/555/615
	5903890750671	RE-STOJAK 815	Stand for WANAS 815/COMBO
	5903890750688	RE-STOJAK 900 H	Stand for WANAS 900H
	5903890750695	RE-STOJAK 1300 H	Stand for WANAS 1300H
	5903890750718	RE-STOJAK NAWILŻACZ	Stand for WANAS UMECTO 600/ WANAS UMECTO 1300
	5903890750725	RE-STOJAK CHŁODN444	Stand for WANAS Water Heater/Cooler 444
	5903890750701	RE-STOJAK CHŁODN426	Stand for WANAS Water Heater/Cooler 426



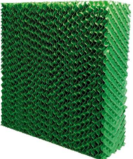





Accessories WANAS

	EAN	Code	Description
 MODUL 010/ONOFF	5903890750565	RE-MODUŁ 010/ONOFF	The module for cooperation with the multiSENSE sensor converts the 0-10 V signal to ON/OFF
 REGULATOR multiSENSE	5903890750558	RE-REGUL.MULTISENSE	multiSense is a wall-mounted, wired controller for CO2, relative humidity and temperature in one housing.
 SENSOR ROOMCONTROL	5903890752019	RE-CZUJNIK ROOMCONTR	Wired sensor, cooperating with the V1 controller, used to measure humidity and room temperature
 SENSOR MINICONTROL	5903890751920	RE-CZUJNIK MINICONTR	Wireless sensor, cooperating with the V2 controller, used to measure humidity and temperature in a room.
 MOBILE CONTROL W-15	5903890750589	RE-MODUŁ INT_W-15	The W-15 module is used for connection of the recuperator with the Internet and enables remote operation of the air handling unit via the Internet.
 MOBILE CONTROL W-19 Wi-Fi	5903890750572	RE-MODUŁ INT_W-19	The Wi-Fi module is used for wireless connection of the recuperator with the Internet and enables remote operation of the air handling unit via the Internet.
 TEMPERATURE SENSOR W-1000	5903890750633	RE-CZUJNIK W-1000	Temperature sensor W-1000 necessary for the installation of an air or glycol GHE. When ordering ground heat exchanger WANAS 426 sensor included in the set.
 WIRE 4x0,14	5903890750626	RE-PRZEWÓD 4X0,14	The cable to connect the WANAS air handling unit with the touch controller.
 SENSOR EXTRA TEMP	5903890750619	RE-CZUJNIK EXTRA TEM	EXTRA TEMP PT-1000 temperature sensor. Installed in the duct, it is used to measure the temperature after the cooler / heater, electric heater or freon cooler
 HUMIDITY PAD	5903890750596 5903890750602	RE-HUMIDITY PAD 100 RE-HUMIDITY PAD 200	Evaporation mat for UMECTO Evaporation mat for : UMECTO 600 - 1 pcs UMECTO 1300 - 2 pcs







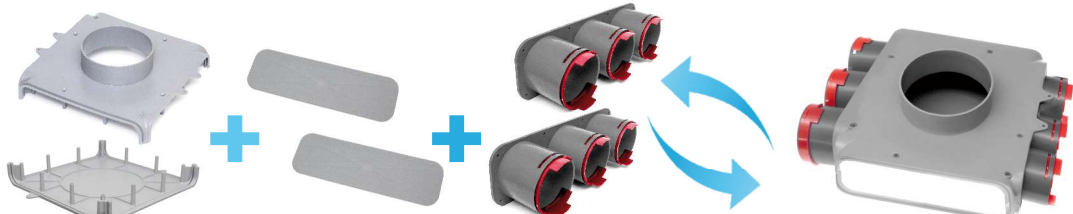

Accessories WANAS

	EAN	Code	Description
 <p>FILTER ISO COARSE 75%</p>	5903890751579	RE-FILTR 24-25 G4UC	WANAS 250 MN
	5903890751982	RE-FILTR 25-25 G4	WANAS 250H
	5903890751593	RE-FILTR GWC_35	WANAS 350
	5903890751609	RE-FILTR 35-40 G4 UC	WANAS 350/2, 350/3,355 and WANAS COMBO
	5903890751630	RE-FILTR 550 G4 UC	WANAS 550
	5903890751623	RE-FILTR 55-60 G4 UC	WANAS 550/2, 550/3 and 555
	5903890751654	RE-FILTR 39-41 G4 UC	WANAS 415
	5903890751678	RE-FILTR 59-61 G4 UC	WANAS 615
	5903890753115	RE-FILTR 20-30 G4 1	WANAS BLACK SUPPLY
5903890753122	RE-FILTR 20-30 G4 2	WANAS BLACK EXHAUST	
 <p>CARBON FILTER ISO COARSE 75%</p>	5903890751616	RE-FILTR 35-40 G4UCW	WANAS 350/2, 350/3, 355 and WANAS COMBO
	5903890751661	RE-FILTR 39-41 G4UCW	WANAS 415
	5903890751647	RE-FILTR 55-60 G4UCW	WANAS 550/2, 550/3 and 555
	5903890751685	RE-FILTR 59-61 G4UCW	WANAS 615
 <p>CASSETTE FILTER ePM 10 50%</p>	5903890751692	RE-FILTR 24-25 M5	WANAS 250 MN
	5903890751999	RE-FILTR 25-25 M5	WANAS 250H
	5903890751722	RE-FILTR 35-40 M5	WANAS 350/2, 350/3 and WANAS COMBO
	5903890751807	RE-FILTR 55-60 M5	WANAS 550/2 and 550/3
	5903890751777	RE-FILTR 39-41 M5	WANAS 415
	5903890751821	RE-FILTR 59-61 M5	WANAS 615
5903890752941	RE-FILTR 20-30 M5	WANAS BLACK	
 <p>HIGH FILTRATION FILTER ePM 1,0 80%</p>	5903890751708	RE-FILTR 24-25 A	WANAS 250MN
	5903890752002	RE-FILTR 25-25 A	WANAS 250H
	5903890751760	RE-FILTR 345-3/401 A	WANAS 345
	5903890751739	RE-FILTR 35-40 A	WANAS 350/2, 350/3, 355 and WANAS COMBO
	5903890751814	RE-FILTR 55-60 A	WANAS 550/2, 550/3 and 555
	5903890751784	RE-FILTR 39-41 A	WANAS 415
	5903890751838	RE-FILTR 59-61 A	WANAS 615
	5903890751883	RE-FILTR 78-81 A	WANAS 815
	5903890751845	RE-FILTR 80-85 A	WANAS 800
	5903890751906	RE-FILTR 90-13 A	WANAS 900H and 1300H
5903890753146	RE-FILTR 20-30 A	WANAS BLACK	
 <p>CASSETTE FILTER ISO COARSE 75%</p>	5903890751586	RE-FILTR 24-25 G4W	WANAS 250MN CARBON NONWOVEN
	5903890751746	RE-FILTR 345-3/401 G4	WANAS 345
	5903890751753	RE-FILTR 345-3/4 G4W	WANAS 345 CARBON NONWOVEN
	5903890751715	RE-FILTR 35-40 G4W	WANAS 350/2, 350/3, 355 and WANAS COMBO CARBON NONWOVEN
	5903890751791	RE-FILTR 55-60 G4W	WANAS 550/2, 550/3, 555 CARBON NONWOVEN
	5903890751852	RE-FILTR 80-85 G4	WANAS 800
	5903890751876	RE-FILTR 78-81 G4NAW	WANAS 815 SUPPLY
	5903890751869	RE-FILTR 78-81 G4WYW	WANAS 815 EXHAUST
	5903890751890	RE-FILTR 90-13 G4	WANAS 900H and 1300H



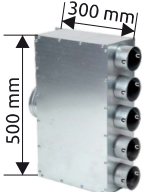

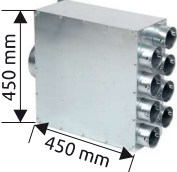
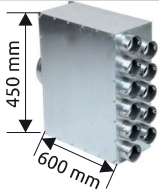

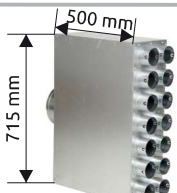

Equipment WANAS MODULAR

	EAN	Code	Description
 <p>BOX SUPPLY / EXHAUST 2XØ75/125</p>	5903890752545	WE-ROZPR. 2X75X125_M	The box is designed for air supply to rooms with a capacity of approx. 60 m ³ /h. Equipped with two locking rings.
 <p>STUB 3XØ75</p>	5903890752552	WE-KRÓCIEC 3X75_M	Stubs are used to change combinations in MODULAR distributors and to assemble an individual spacing. Equipped with three locking rings. Distributors can be equipped with 3, 6, 9 and 12 stubs.
 <p>AIR DISTRIBUTOR 9XØ75/160 OR 200</p>	5903890752569 5903890752576	WE-ROZDZ. 9X75X160_M WE-ROZDZ. 9X75X200_M	The design of the distributor allows it to be installed in floor layers, suspended ceilings, as well as in framed walls. The distributor is compatible with all available Ø75, Ø160, Ø200 ventilation ducts.
 <p>AIR DISTRIBUTOR 12XØ75/160 OR 200</p>	5903890752583 5903890752590	WE-ROZDZ-12X75X160_M WE-ROZDZ-12X75X200_M	The design of the distributor allows it to be installed in floor layers, suspended ceilings, as well as in framed walls. The distributor is compatible with all available Ø75, Ø160, Ø200 ventilation ducts.
 <p>PLUG</p>	5903890752606	WE-ZAŚLEPKA_M	It is used to cover the unused side of the MODULAR distributor.
 <p>DISTRIBUTOR PLATE Ø160 OR Ø200</p>	5903890752613 5903890752620	WE-PŁYTA-160_M WE-PŁYTA-200_M	Plate with a connection stub to the MODULAR distributor Ø160 and Ø200. It enables the assembly of a custom distributor option.
 <p>BUILT-IN MODULE</p>	5903890752637	WE-MODUŁ_M	Solid plate for MODULAR manifold. Allows you to assemble your own manifold option.
 <p>SCREWS</p>	5903890752644	WE-ŚRUBY_M	Screws for joining the WANAS MODULAR components - 12 pieces
			

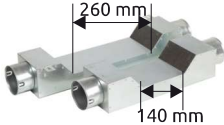
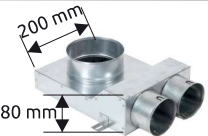
Ventilation Equipment WANAS







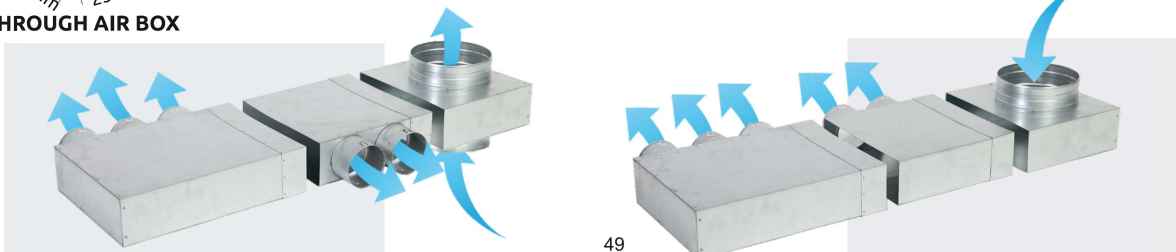



	EAN	Kod	Description
 <p>SUPPLY AIR BOX 1XØ75/100</p>	5903890751258	WE-ROZPR. 1X75X100	The box is designed for air supply to rooms with a capacity of approx. 30 m ³ /h.
 <p>SUPPLY AIR BOX 2XØ75/125</p>	5903890751265	WE-ROZPR. 2X75X125	The box is designed for air supply to rooms with a capacity of approx. 60 m ³ /h.
 <p>SUPPLY AIR BOX 3XØ75/150</p>	5903890751272	WE-ROZPR. 3X75X150	The box is designed for air supply to rooms with a capacity of approx. 90 m ³ /h.
 <p>AIR DISTRIBUTOR 5XØ75/125</p>	5903890750787	WE-ROZDZ-5X75X125	Width - 500mm Length - 300mm Height - 90mm
 <p>INSULATED AIR DISTRIBUTOR 5XØ75/125</p>	5903890750794	WE-ROZDZ-5X75X125 I	Width - 500mm Length - 300mm Height - 90mm
 <p>AIR DISTRIBUTOR 8XØ75/160</p>	5903890750800	WE-ROZDZ-8X75X160	Width - 300mm Length - 683mm Height - 90mm
 <p>INSULATED AIR DISTRIBUTOR 8XØ75/160</p>	5903890750817	WE-ROZDZ-8X75X160 I	Width - 450mm Length - 450mm Height - 190mm
 <p>INSULATED AIR DISTRIBUTOR 11XØ75/200</p>	5903890750824	WE-ROZDZ-11X75X200 I	Width - 450mm Length - 600mm Height - 220mm
 <p>INSULATED AIR DISTRIBUTOR 12XØ75/200</p>	5903890750848	WE-ROZDZ-12X75X200 I	Width - 450mm Length - 600mm Height - 220mm

Ventilation Equipment WANAS

	EAN	Code	Description
 <p>AIR DISTRIBUTOR 12XØ75/200</p>	5903890750831	WE-ROZDZ-12X75X200	Width - 330mm Length - 660mm Height - 90mm
 <p>INSULATED AIR DISTRIBUTOR 14XØ75/200</p>	5903890750855	WE-ROZDZ-14X75X200 I	Width - 500mm Length - 715mm Height - 220mm
 <p>CORNER AIR DISTRIBUTOR 2XØ75/125</p>	5903890751289	WE-ROZPR. 2X75X125 N	Width - 300 mm Length - 300 mm Height - 430mm
 <p>PIPE BYPASS</p>	5903890750893 5903890750886	WE-SK-ODSADZ D WE-SK-ODSADZ M	260x44 140x44
 <p>CEILING AIR BOX FOR PLASTERBOARD</p>	5903890750909	WE-ROZPR. 2X75X125 S	Height - 80 mm, 2xØ75 1xØ125 Building height K/G 100 mm
 <p>AIR BOX 2xØ75</p>	5903890751319	WE-K 2X75 PRZELOT	Through
 <p>AIR BOX 3xØ75</p>	5903890751296 5903890751302	WE-K 3X75 PRZELOT WE-K 3X75 ZAMK	Through Closed
 <p>CLOSED AIR BOX</p>	5903890751326	WE-K 200/160 ZAMK	Ø200/Ø160
 <p>CLOSED AIR BOX</p>	5903890751333	WE-K 160 ZAMK	1xØ160
 <p>THROUGH AIR BOX</p>	5903890751340	WE-K 160 PRZELOT	1xØ160



Ventilation Equipment WANAS

	EAN	Code	Description
 SUPPLY AIR DIFFUSER	5903890750954	WE-ZAW-NAW-100	Ø100
	5903890750961	WE-ZAW-NAW-125	Ø125
	5903890750978	WE-ZAW-NAW-150	Ø150
 EXHAUST AIR DIFFUSER	5903890750985	WE-ZAW-WYW-100	Ø100
	5903890750992	WE-ZAW-WYW-125	Ø125
	5903890751005	WE-ZAW-WYW-150	Ø150
 GALVANIZED WALL EXTERNAL INTAKE/OUTTAKE	5903890751012	WE-CK 330X330_OCYNK	Ø200, 330x330
	5903890751043	WE-CK 330X330_GRAFIT	Ø200, 330x330 - RAL: 7016
	5903890751029	WE-CK 330X330_SZARA	Ø200, 330x330 - RAL: 7047
	5903890751036	WE-CK 330X330_BIAŁA	Ø200, 330x330 - RAL: 9016
	5903890751050	WE-CK 380X380_OCYNK	Ø250, 380x380
	5903890751081	WE-CK 380X380_GRAFIT	Ø250, 380x380 - RAL: 7016
	5903890751067	WE-CK 380X380_SZARA	Ø250, 380x380 - RAL: 7047
5903890751074	WE-CK 380X380_BIAŁA	Ø250, 380x380 - RAL: 9016	
 ALUMINUM WALL EXTERNAL INTAKE/OUTTAKE	5903890751111	WE-CO 160_GRAFIT	Ø160 - RAL: 7016
	5903890751104	WE-CO 160_SZARA	Ø160 - RAL: 7047
	5903890751098	WE-CO 160_BIAŁA	Ø160 - RAL: 9016
	5903890751142	WE-CO 200_GRAFIT	Ø200 - RAL: 7016
	5903890751135	WE-CO 200_SZARA	Ø200 - RAL: 7047
	5903890751128	WE-CO 200_BIAŁA	Ø200 - RAL: 9016
	5903890751173	WE-CO 250_GRAFIT	Ø250 - RAL: 7016
5903890751166	WE-CO 250_SZARA	Ø250 - RAL: 7047	
5903890751159	WE-CO 250_BIAŁA	Ø250 - RAL: 9016	
 ACOUSTIC AIR DAMPER	5903890751180	WE-TŁUMIK 200/500	Ø200x500
	5903890751197	WE-TŁUMIK 200/1000	Ø200x1000
	5903890751203	WE-TŁUMIK 250/500	Ø250x500
	5903890751210	WE-TŁUMIK 250/1000	Ø250x1000
 FLEXIBLE INSULATED DUCT 25 MM	5903890751227	WE-KANAŁ ELAST 160	Insulated flexible conduit Ø160
	5903890751234	WE-KANAŁ ELAST 200	Insulated flexible conduit Ø203
	5903890751241	WE-KANAŁ ELAST 254	Insulated flexible conduit Ø254
 AIR ELASTIC DUCT Ø75/50mb	5903890750916	WE-KANAŁ 75	The Ø75 ventilation duct serves to distribute air from supply air box to air distributor. The pipe can be spread on the ceiling in the heated zone in a layer of 8 cm polystyrene or in the attic covered with min. 10 cm thick layer of styrofoam.
 MUFF	5903890750923	WE-MUFA 75	The fitting is designed to connect the Ø75 flexible duct.
 PLUG	5903890750930	WE-ZAŚLEPKA 75	The plug is designed to plug unused holes in air distributors and air supply boxes and to protect them from possible dirt.
 GASKET	5903890750947	WE-USZCZELKA 75	The gasket is designed to be placed on Ø75 flexible ducts to ensure tightness of connection between duct pipe and distributions boxes, supply air boxes and muff.
 GHE TEE	5903890750862	WE-TRÓJNIK GWC 160	The T-connector for selecting the air intake Ø160
	5903890750879	WE-TRÓJNIK GWC 200	enables the selection of a wall or ground intake Ø200 with Belimo actuator

EFFICIENCY OF ENTHALPY EXCHANGERS

Air flow	Wanas 350		Wanas 415		Wanas 550		Wanas 815	
	η_T	η_{H_2O}	η_T	η_{H_2O}	η_T	η_{H_2O}	η_T	η_{H_2O}
100 m ³ /h	84,3%	68,5%	86,3%	76,5%	84,6%	69,5%	-	-
200 m ³ /h	78,5%	55,4%	79,4%	62,8%	79,7%	58%	85,4%	74,9%
300 m ³ /h	73,8%	45,9%	74,2%	53,1%	75,1%	48,3%	81,4%	67,2%
400 m ³ /h	70,4%	40,2%	70,7%	47,5%	71%	40,3%	78%	60,6%
500 m ³ /h	-	-	-	-	-	-	75,1%	55,3%
600 m ³ /h	-	-	-	-	-	-	72,9%	51,2%

Values:

Temp. in = 20°C
 Temp. out = -5°C
 RH_i = 45%
 RH_o = 70%

Signs:

Temp. in - Internal temperature
 Temp. out - Outside temperature
 RH_i - Indoor humidity
 RH_o - Outside humidity

η_{RH} CALCULATE RECOVERY

$$\frac{RH_1 - RH_2}{RH_3 - RH_2} \times 100\%$$

RH₁ - Humidity of the air supplied to the rooms [g/m³]
 RH₂ - Humidity of the air drawn from the outside [g/m³]
 RH₃ - Humidity of the air drawn from the rooms [g/m³]

CALCULATOR FOR RECOVERY

η_T CALCULATE EFFICIENCY

$$\frac{T_1 - T_2}{T_3 - T_2} \times 100\%$$

T₁ - Temperature of the air supplied to the rooms
 T₂ - Temperature of the air drawn from the outside of the building
 T₃ - Temperature of the air drawn from rooms



DOWNLOAD THE CALCULATOR FOR YOUR SMARTPHONE

CHOOSE

PRE-HEATERS

Calculate the rise in air temperature in relation to the flow in m³/h and the heater power in Watts



DOWNLOAD THE CALCULATOR FOR YOUR SMARTPHONE

CHOOSE

DIAMETER OF CHANNELS

Calculate the optimal diameter of the channels for the installation, based on the flow rate in m³/h, while maintaining the proper flow velocity in m³/s



DOWNLOAD THE CALCULATOR FOR YOUR SMARTPHONE



WANAS

Ul. Miłocińska 4B,
35-232 Rzeszów, POLAND
tel: +48 570 947 020
e-mail: export@wanas.pl

www.en.wanas.pl

The manufacturer reserves the right to change parameters/dimensions at any time.
The above leaflet is not a commercial offer.

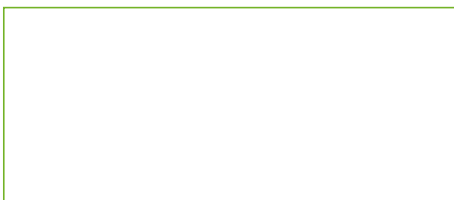

distributor

